

# Dell™ Inspiron™ One 2320

# Owner's Manual

**Regulatory model: W03C** **Regulatory type: W03C001**

# Notes, Cautions, and Warnings



**NOTE:** A NOTE indicates important information that helps you make better use of your computer.



**CAUTION:** A CAUTION indicates either potential damage to hardware or loss of data and tells you how to avoid the problem.



**WARNING:** A WARNING indicates a potential for property damage, personal injury, or death.

---

**Information in this document is subject to change without notice.**

**© 2011 Dell Inc. All rights reserved.**

Reproduction of these materials in any manner whatsoever without the written permission of Dell Inc. is strictly forbidden.

Trademarks used in this text: Dell™, the DELL™ logo, and Inspiron™ are trademarks of Dell Inc.; Microsoft®, Windows®, and the Windows start button logo are either trademarks or registered trademarks of Microsoft Corporation in the United States and/or other countries.

Other trademarks and trade names may be used in this document to refer to either the entities claiming the marks and names or their products. Dell Inc. disclaims any proprietary interest in trademarks and trade names other than its own.

# Contents

1	Before You Begin . . . . .	11
	<b>Recommended Tools.</b> . . . . .	11
	<b>Turning Off Your Computer.</b> . . . . .	11
	<b>Safety Instructions.</b> . . . . .	11
2	Technical Overview . . . . .	15
	<b>Inside View of Your Inspiron One</b> . . . . .	15
	<b>System Board Components</b> . . . . .	17
3	Back Cover . . . . .	19
	<b>Removing the Back Cover.</b> . . . . .	19
	<b>Replacing the Back Cover.</b> . . . . .	21
4	Hard Drive . . . . .	23
	<b>Removing the Hard Drive</b> . . . . .	23
	<b>Replacing the Hard Drive</b> . . . . .	25
5	Optical Drive . . . . .	27
	<b>Removing the Optical Drive</b> . . . . .	27

	<b>Replacing the Optical Drive . . . . .</b>	<b>29</b>
<b>6</b>	<b>Memory Module(s) . . . . .</b>	<b>31</b>
	<b>Removing Memory Module(s) . . . . .</b>	<b>31</b>
	<b>Replacing Memory Module(s) . . . . .</b>	<b>33</b>
<b>7</b>	<b>Rear-Stand Assembly . . . . .</b>	<b>35</b>
	<b>Removing the Rear-Stand Assembly. . . . .</b>	<b>35</b>
	<b>Replacing the Rear-Stand Assembly . . . . .</b>	<b>36</b>
<b>8</b>	<b>VESA Mount. . . . .</b>	<b>37</b>
	<b>Removing the VESA Mount . . . . .</b>	<b>37</b>
	<b>Replacing the VESA Mount . . . . .</b>	<b>38</b>
<b>9</b>	<b>I/O Cover . . . . .</b>	<b>39</b>
	<b>Rear I/O Cover . . . . .</b>	<b>39</b>
	Removing the Rear I/O Cover . . . . .	39
	Replacing the Rear I/O Cover. . . . .	40
	<b>Side I/O Cover . . . . .</b>	<b>41</b>
	Removing the Side I/O Cover . . . . .	41
	Replacing the Side I/O Cover . . . . .	41
<b>10</b>	<b>Audio Video Board (Optional) . . . . .</b>	<b>43</b>
	<b>Removing the Audio Video (AV) Board . . . . .</b>	<b>43</b>

	<b>Replacing the Audio Video (AV) Board . . . . .</b>	<b>45</b>
<b>11</b>	<b>Converter Board . . . . .</b>	<b>47</b>
	<b>Removing the Converter Board . . . . .</b>	<b>47</b>
	<b>Replacing the Converter Board . . . . .</b>	<b>48</b>
<b>12</b>	<b>B-CAS Card (Optional) . . . . .</b>	<b>51</b>
	<b>Removing the B-CAS Card . . . . .</b>	<b>51</b>
	<b>Replacing the B-CAS Card . . . . .</b>	<b>52</b>
<b>13</b>	<b>System-Board Shield . . . . .</b>	<b>53</b>
	<b>Removing the System-Board Shield . . . . .</b>	<b>53</b>
	<b>Replacing the System-Board Shield . . . . .</b>	<b>54</b>
<b>14</b>	<b>Coin-Cell Battery . . . . .</b>	<b>57</b>
	<b>Removing the Coin-Cell Battery . . . . .</b>	<b>57</b>
	<b>Replacing the Coin-Cell Battery . . . . .</b>	<b>58</b>
<b>15</b>	<b>Wireless Mini-Card(s) . . . . .</b>	<b>61</b>
	<b>Removing the Mini-Card(s) . . . . .</b>	<b>61</b>
	<b>Replacing the Mini-Card(s) . . . . .</b>	<b>63</b>

16 System Board . . . . .	65
<b>Removing the System Board . . . . .</b>	<b>65</b>
<b>Replacing the System Board . . . . .</b>	<b>66</b>
<b>Entering the Service Tag in the BIOS . . . . .</b>	<b>67</b>
17 Feet . . . . .	69
<b>Removing the Feet . . . . .</b>	<b>69</b>
<b>Replacing the Feet . . . . .</b>	<b>70</b>
18 Middle Frame . . . . .	71
<b>Removing the Middle Frame . . . . .</b>	<b>71</b>
<b>Replacing the Middle Frame . . . . .</b>	<b>72</b>
19 Processor Heat-Sink Fan . . . . .	75
<b>Removing the Processor Heat-Sink Fan . . . . .</b>	<b>75</b>
<b>Replacing the Processor Heat-Sink Fan . . . . .</b>	<b>76</b>
20 Processor Heat-Sink . . . . .	79
<b>Removing the Processor Heat-Sink . . . . .</b>	<b>79</b>
<b>Replacing the Processor Heat-Sink . . . . .</b>	<b>80</b>

21	Processor . . . . .	83
	<b>Removing the Processor.</b> . . . . .	83
	<b>Replacing the Processor</b> . . . . .	84
22	Antenna-In Connector . . . . .	89
	<b>Removing the Antenna-In Connector</b> . . . . .	89
	<b>Replacing the Antenna-In Connector</b> . . . . .	90
23	Antenna Module . . . . .	93
	<b>Removing the Antenna Module</b> . . . . .	93
	<b>Replacing the Antenna Module</b> . . . . .	94
24	Power-Button Board . . . . .	97
	<b>Removing the Power-Button Board</b> . . . . .	97
	<b>Replacing the Antenna-In Connector</b> . . . . .	98
25	Speakers . . . . .	101
	<b>Removing the Speakers</b> . . . . .	101
	<b>Replacing the Speakers</b> . . . . .	102
26	Touch-Screen Control Board (Optional)	105
	<b>Removing the Touch-Screen Control Board.</b> . . . . .	105

	<b>Replacing the Touch-Screen Control Board. . . . .</b>	<b>106</b>
<b>27</b>	<b>Display. . . . .</b>	<b>109</b>
	<b>Display Assembly . . . . .</b>	<b>109</b>
	Removing the Display Assembly . . . . .	109
	Replacing the Display Assembly . . . . .	111
	<b>Display Panel. . . . .</b>	<b>113</b>
	Removing the Display Panel . . . . .	113
	Replacing the Display Panel . . . . .	113
	<b>Display-Panel Brackets . . . . .</b>	<b>114</b>
	Removing the Display-Panel Brackets . . . . .	114
	Replacing the Display-Panel Brackets . . . . .	115
<b>28</b>	<b>Camera Module . . . . .</b>	<b>117</b>
	<b>Removing the Camera Module. . . . .</b>	<b>117</b>
	<b>Replacing the Camera Module . . . . .</b>	<b>118</b>
<b>29</b>	<b>Speaker Cover . . . . .</b>	<b>121</b>
	<b>Removing the Speaker Cover . . . . .</b>	<b>121</b>
	<b>Replacing the Speaker Cover . . . . .</b>	<b>122</b>
<b>30</b>	<b>System Setup . . . . .</b>	<b>125</b>
	<b>Overview . . . . .</b>	<b>125</b>
	Entering System Setup . . . . .	125
	System Setup Options . . . . .	126



Boot Sequence . . . . .	131
<b>Clearing Forgotten Passwords . . . . .</b>	<b>132</b>
<b>Clearing CMOS Passwords . . . . .</b>	<b>134</b>
31 Flashing the BIOS . . . . .	137



## Before You Begin

This manual provides procedures for removing and installing the components in your computer. Unless otherwise noted, each procedure assumes that the following conditions exist:

- You have performed the steps in "Turning Off Your Computer" on page 11 and "Safety Instructions" on page 11.
- You have read the safety information that shipped with your computer.
- A component can be replaced or—if purchased separately—installed by performing the removal procedure in reverse order.

## Recommended Tools

The procedures in this document may require the following tools:

- Small Phillips screwdriver
- Hex nut driver
- Flash BIOS executable update program available at [support.dell.com](http://support.dell.com)

## Turning Off Your Computer

 **CAUTION: To avoid losing data, save and close all open files and exit all open programs before you turn off your computer.**

- 1 Save and close all open files and exit all open programs.
- 2 To shut down the operating system, click **Start**  and then click **Shut Down**.
- 3 Ensure that the computer is turned off. If your computer did not automatically turn off when you shut down the operating system, press and hold the power button until the computer turns off.

## Safety Instructions

Use the following safety guidelines to help protect your computer from potential damage and to help to ensure your own personal safety.

 **WARNING:** Before working inside your computer, read the safety information that shipped with your computer. For additional safety best practices information, see the Regulatory Compliance Homepage at [dell.com/regulatory\\_compliance](http://dell.com/regulatory_compliance).

 **WARNING:** Disconnect all power sources before opening the enclosure to replace, remove, or install accessories. After the installation is completed, the enclosure must be replaced and all fasteners installed before connecting to the power source.

 **CAUTION:** Only a certified service technician is authorized to remove the computer cover and access any of the components inside the computer. See the safety instructions for complete information about safety precautions, working inside your computer, and protecting against electrostatic discharge.

 **CAUTION:** To avoid electrostatic discharge, ground yourself by using a wrist grounding strap or by periodically touching an unpainted metal surface (such as a connector on your computer).

 **CAUTION:** When you disconnect a cable, pull on its connector or on its pull-tab, not on the cable itself. Some cables have connectors with locking tabs; if you are disconnecting this type of cable, press in on the locking tabs before you disconnect the cable. As you pull connectors apart, keep them evenly aligned to avoid bending any connector pins. Also, before you connect a cable, ensure that both connectors are correctly oriented and aligned.

 **CAUTION:** To avoid damaging the computer, perform the following steps before you begin working inside the computer.

- 1 Ensure that the work surface is flat and clean to prevent the computer display from being scratched.
- 2 Turn off your computer and all attached devices. See "Turning Off Your Computer" on page 11.

 **CAUTION:** To disconnect a network cable, first unplug the cable from your computer and then unplug the cable from the network device.

- 3 Disconnect all telephone or network cables from the computer.
- 4 Disconnect your computer and all attached devices from their electrical outlets.
- 5 Disconnect all attached devices from your computer.
- 6 Press and hold the power button while the computer is unplugged to ground the system board.



**CAUTION:** Before touching anything inside your computer, ground yourself by touching an unpainted metal surface, such as the metal at the back of the computer. While you work, periodically touch an unpainted metal surface to dissipate static electricity, which could harm internal components.



# Technical Overview

- !** **WARNING:** Before working inside your computer, read the safety information that shipped with your computer. For additional safety best practices information, see the Regulatory Compliance Homepage at [dell.com/regulatory\\_compliance](http://dell.com/regulatory_compliance).
- △** **CAUTION:** Only a certified service technician should perform repairs on your computer. Damage due to servicing that is not authorized by Dell is not covered by your warranty.
- △** **CAUTION:** To avoid electrostatic discharge, ground yourself by using a wrist grounding strap or by periodically touching an unpainted metal surface (such as a connector on your computer).

## Inside View of Your Inspiron One

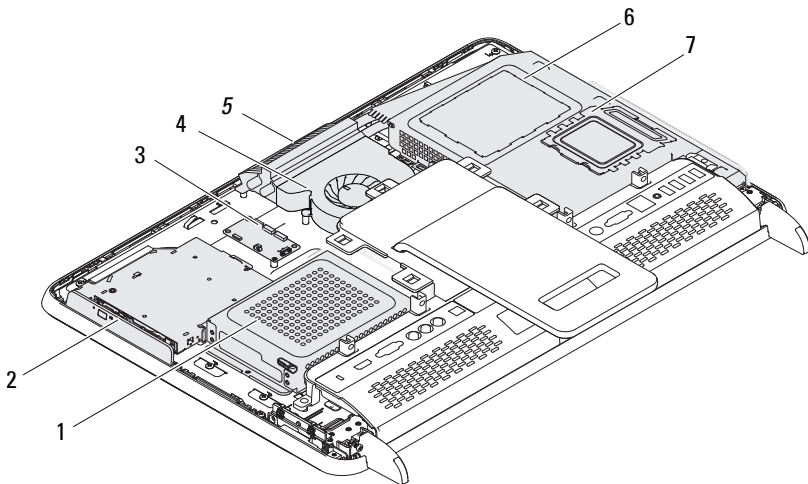

- |   |  |   |                         |
|---|--|---|-------------------------|
| 1 | hard drive                               | 2 | optical drive           |
| 3 | touch-screen control board<br>(optional) | 4 | processor heat-sink fan |
| 5 | camera module                            | 6 | system-board shield     |
| 7 | memory-module cover                      |   |                         |





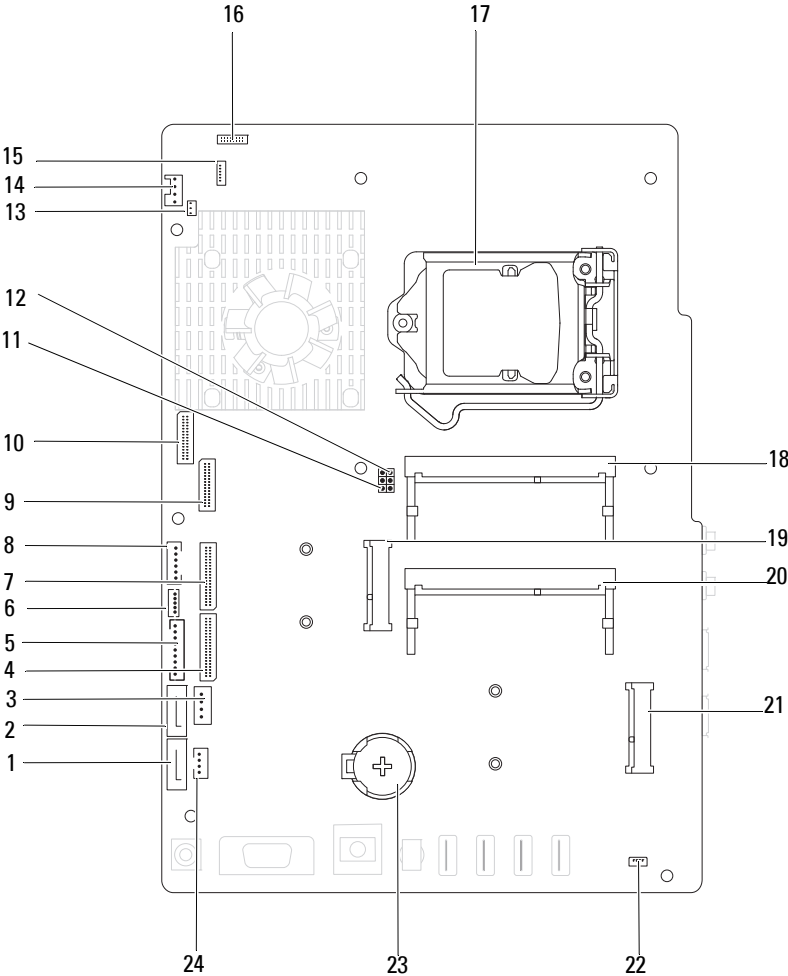

# System Board Components



1	SATA connector (ODD)	2	SATA connector (HDD)
3	hard-drive power cable connector (HDD PWR)	4	AV-board cable connector (UMA)
5	display-panel power cable connector	6	touch-screen cable connector (Touch)
7	AV-board cable connector (GPU)	8	power-button and hard-drive activity light cable connector
9	LVDS-cable connector (UMA)	10	LVDS-cable connector (GPU)
11	password reset jumper (PASSWORD_CLEAR)	12	CMOS reset jumper (CMOS_CLEAR)
13	infrared blaster cable connector (CIR Emitter)	14	system-fan cable connector
15	IR-cable connector	16	camera-cable connector
17	processor socket	18	memory-module connector (CHA-DIMM)
19	Mini-Card connector	20	memory-module connector (CHB-DIMM)
21	Mini-Card connector (TV)	22	speaker-cable connector (CN 10)
23	battery socket (CMOS)	24	optical-drive power cable connector (ODD PWR)

## Back Cover

-  **WARNING:** Before working inside your computer, read the safety information that shipped with your computer. For additional safety best practices information, see the Regulatory Compliance Homepage at [dell.com/regulatory\\_compliance](http://dell.com/regulatory_compliance).
-  **CAUTION:** Only a certified service technician should perform repairs on your computer. Damage due to servicing that is not authorized by Dell is not covered by your warranty.
-  **CAUTION:** To avoid electrostatic discharge, ground yourself by using a wrist grounding strap or by periodically touching an unpainted metal surface (such as a connector on your computer).
-  **CAUTION:** Ensure that sufficient space exists to support the computer with the computer cover removed—at least 30 cm (1 ft.) of desk top space.

## Removing the Back Cover

- 1 Follow the instructions in "Before You Begin" on page 11.
-  **CAUTION:** Before opening your computer, ensure that you place the computer on a soft cloth or clean surface to avoid any scratches on the display.
- 2 Place the computer face down on a flat surface.
  - 3 Remove the six screws that secure the back cover to the computer.

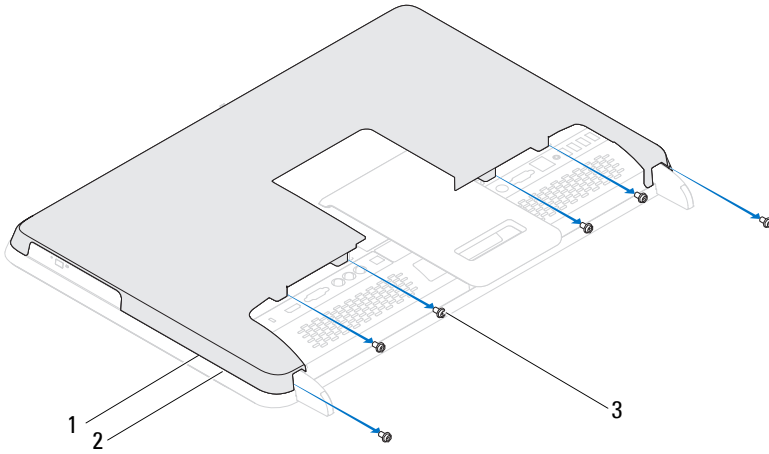

1 back cover

2 middle frame

3 screws (6)

- 4 Pry up the back cover from the tabs off the middle frame and lift the back cover off the computer.

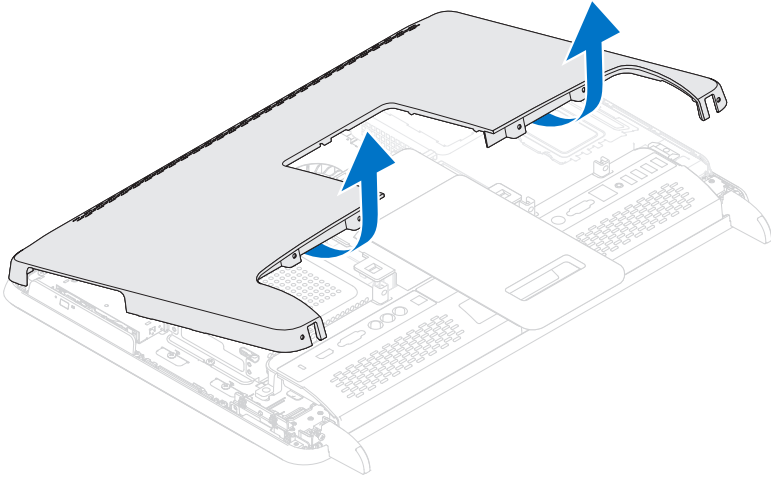

- 5 Place the back cover in a secure location.

## Replacing the Back Cover

- 1 Follow the instructions in "Before You Begin" on page 11.
- 2 Align the tabs on the top of the back cover with the slots on the middle frame.
- 3 Align the tabs on the sides of the back cover with the slots on the middle frame and then fix the back cover into place.
- 4 Replace the six screws that secure the back cover to the computer.
- 5 Place the computer in an upright position.



**CAUTION:** Before turning on the computer, replace all screws and ensure that no stray screws remain inside the computer. Failure to do so may result in damage to the computer.

- 6 Connect your computer and all attached devices to electrical outlets, and turn them on.





# Hard Drive

 **WARNING:** Before working inside your computer, read the safety information that shipped with your computer. For additional safety best practices information, see the Regulatory Compliance Homepage at [dell.com/regulatory\\_compliance](http://dell.com/regulatory_compliance).

 **WARNING:** If you remove the hard drive from the computer when the drive is hot, *do not touch* the metal housing of the hard drive.

 **CAUTION:** Only a certified service technician should perform repairs on your computer. Damage due to servicing that is not authorized by Dell is not covered by your warranty.

 **CAUTION:** To avoid electrostatic discharge, ground yourself by using a wrist grounding strap or by periodically touching an unpainted metal surface (such as a connector on your computer).

 **CAUTION:** To prevent data loss, turn off your computer (see "Turning Off Your Computer" on page 11) before removing the hard drive. Do not remove the hard drive while the computer is On or in Sleep state.

 **CAUTION:** Hard drives are extremely fragile. Exercise care when handling the hard drive.

 **NOTE:** Dell does not guarantee compatibility or provide support for hard drives from sources other than Dell.

 **NOTE:** If you are installing a hard drive from a source other than Dell, you need to install an operating system, drivers, and utilities on the new hard drive.

## Removing the Hard Drive

- 1 Follow the instructions in "Before You Begin" on page 11.
- 2 Remove the back cover. See "Removing the Back Cover" on page 19.
- 3 Remove the screw that secures the hard-drive assembly to the chassis.
- 4 Slide and lift the hard-drive assembly and then disconnect the power and data cables from the connector on the hard drive.

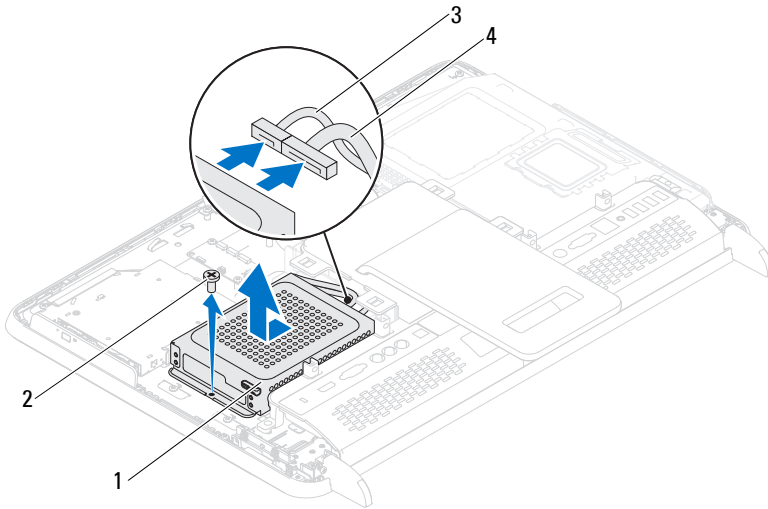

- |   |                     |   |             |
|---|---------------------|---|-------------|
| 1 | hard-drive assembly | 2 | screw (1)   |
| 3 | data cable          | 4 | power cable |

- 5 Remove the four screws that secure the hard-drive cage to the hard drive.
- 6 Slide the hard-drive cage away from the hard drive.



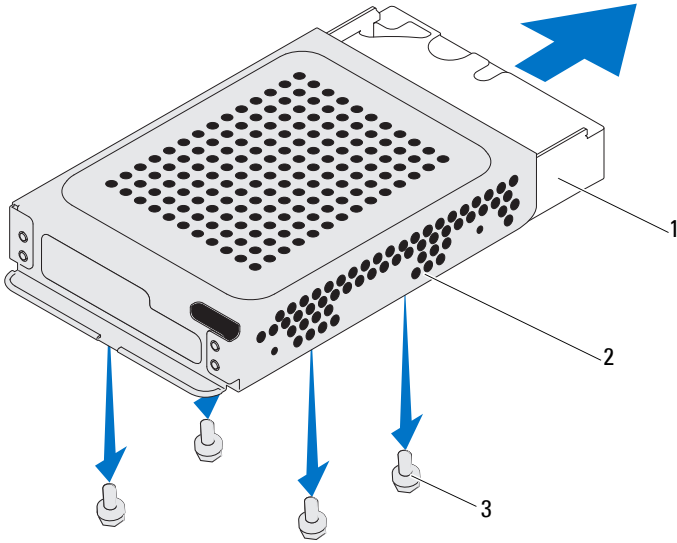

- 1 hard drive
- 3 screws (4)

- 2 hard-drive cage

## Replacing the Hard Drive

- 1 Follow the instructions in "Before You Begin" on page 11.
- 2 Slide the hard drive into the hard-drive cage, and align the screw holes on the hard-drive cage with the screw holes on the hard drive.
- 3 Replace the four screws that secure the hard-drive cage to the hard drive.
- 4 Connect the power and data cables to the connector on the hard drive.
- 5 Place the hard-drive assembly on the chassis and slide the hard-drive assembly into place.
- 6 Replace the screw that secures the hard-drive assembly to the chassis.
- 7 Replace the back cover. See "Replacing the Back Cover" on page 21.



**CAUTION: Before turning on the computer, replace all screws and ensure that no stray screws remain inside the computer. Failure to do so may result in damage to the computer.**

- 8 Connect your computer and all attached devices to electrical outlets, and turn them on.

# Optical Drive

 **WARNING:** Before working inside your computer, read the safety information that shipped with your computer. For additional safety best practices information, see the Regulatory Compliance Homepage at [dell.com/regulatory\\_compliance](http://dell.com/regulatory_compliance).

 **CAUTION:** Only a certified service technician should perform repairs on your computer. Damage due to servicing that is not authorized by Dell is not covered by your warranty.

 **CAUTION:** To avoid electrostatic discharge, ground yourself by using a wrist grounding strap or by periodically touching an unpainted metal surface (such as a connector on your computer).

## Removing the Optical Drive

- 1 Follow the instructions in "Before You Begin" on page 11.
- 2 Remove the back cover. See "Removing the Back Cover" on page 19.
- 3 Disconnect the power and data cables from the connector on the optical drive.
- 4 Remove the screw that secures the optical-drive assembly to the chassis.
- 5 Slide the optical-drive assembly out of the optical-drive bay.

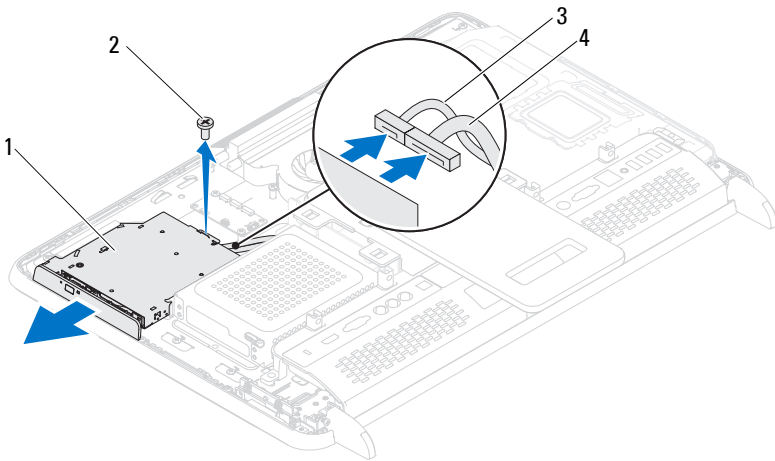

1 optical-drive assembly

2 screw

3 data cable

4 power cable

**6** Remove the two screws that secure the optical-drive bracket to the rear of the optical drive.

**7** Remove the optical-drive bracket away from the optical drive.

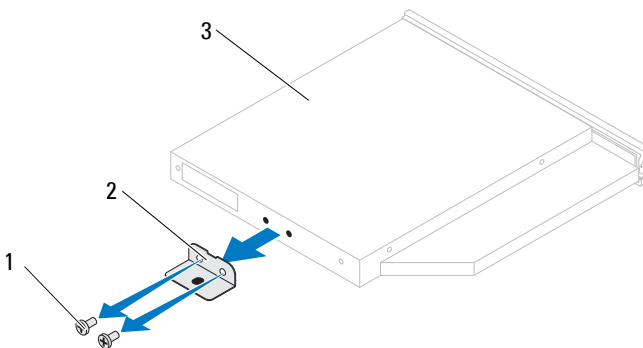

- 1 screws (2)
- 2 optical-drive bracket
- 3 optical drive

## Replacing the Optical Drive



- 1 Follow the instructions in "Before You Begin" on page 11.
- 2 Align the screw holes on the optical-drive bracket with the screw holes on the optical drive.
- 3 Replace the two screws that secure the optical-drive bracket to the optical drive.
- 4 Slide the optical-drive assembly into the optical-drive bay.
- 5 Replace the screw that secures the optical-drive assembly to the chassis.
- 6 Connect the power and data cables to the connector on the optical drive.
- 7 Replace the back cover. See "Replacing the Back Cover" on page 21.

 **CAUTION: Before turning on the computer, replace all screws and ensure that no stray screws remain inside the computer. Failure to do so may result in damage to the computer.**

- 8 Connect your computer and all attached devices to electrical outlets, and turn them on.



## Memory Module(s)

-  **WARNING:** Before working inside your computer, read the safety information that shipped with your computer. For additional safety best practices information, see the Regulatory Compliance Homepage at [dell.com/regulatory\\_compliance](http://dell.com/regulatory_compliance).
-  **CAUTION:** Only a certified service technician should perform repairs on your computer. Damage due to servicing that is not authorized by Dell is not covered by your warranty.
-  **CAUTION:** To avoid electrostatic discharge, ground yourself by using a wrist grounding strap or by periodically touching an unpainted metal surface (such as a connector on your computer).

## Removing Memory Module(s)

- 1 Follow the instructions in "Before You Begin" on page 11.
- 2 Remove the back cover. See "Removing the Back Cover" on page 19.
- 3 Using the slots on the memory-module shield, lift the memory-module shield away from the system-board shield.

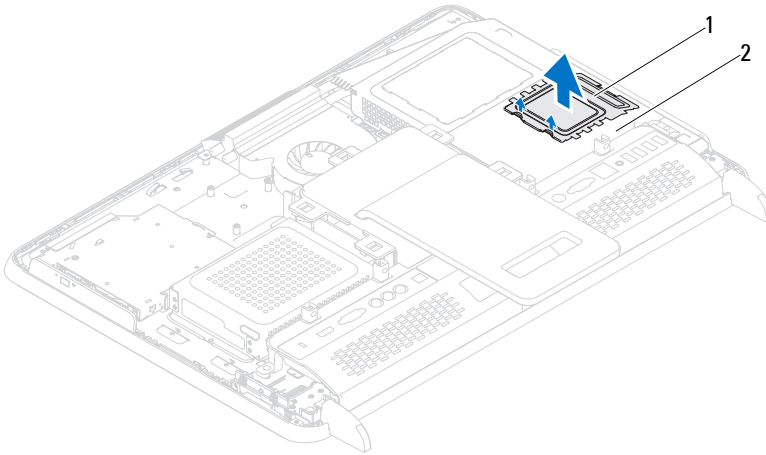

1 memory-module shield

2 system-board shield

- 4 Use your fingertips to carefully spread apart the securing clips on each end of the memory-module connector until the memory module pops up.
- 5 Remove the memory module from the memory-module connector.

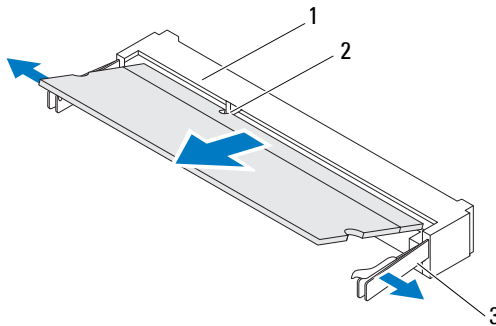



- 1 memory-module connector
- 2 notch
- 3 securing clips (2)

## Replacing Memory Module(s)

 **CAUTION: If the memory module is not installed properly, the computer may not boot.**

- 1 Follow the instructions in "Before You Begin" on page 11.
- 2 Align the notch in the memory module with the tab in the memory-module connector.

Slide the memory module firmly into the slot at a 45-degree angle, and press the memory module down until it clicks into place. If you do not hear the click, remove the memory module and reinstall it.

- 3 Place the memory-module shield on the system-board shield and snap the memory-module shield into place.
- 4 Replace the back cover. See "Replacing the Back Cover" on page 21.

 **CAUTION: Before turning on the computer, replace all screws and ensure that no stray screws remain inside the computer. Failure to do so may result in damage to the computer.**



- 5 Connect your computer and all attached devices to electrical outlets, and then turn them on.
- 6 When the message appears stating that memory size has changed, press <F1> to continue.
- 7 Log on to your computer.

To verify that the memory is installed correctly, click **Start**  → **Control Panel** → **System and Security** → **System**.

Check the amount of memory (RAM) listed.



## Rear-Stand Assembly

-  **WARNING:** Before working inside your computer, read the safety information that shipped with your computer. For additional safety best practices information, see the Regulatory Compliance Homepage at [dell.com/regulatory\\_compliance](http://dell.com/regulatory_compliance).
-  **CAUTION:** Only a certified service technician should perform repairs on your computer. Damage due to servicing that is not authorized by Dell is not covered by your warranty.
-  **CAUTION:** To avoid electrostatic discharge, ground yourself by using a wrist grounding strap or by periodically touching an unpainted metal surface (such as a connector on your computer).

## Removing the Rear-Stand Assembly

- 1 Follow the instructions in "Before You Begin" on page 11.
- 2 Remove the back cover. See "Removing the Back Cover" on page 19.
- 3 Remove the two screws that secure the rear-stand assembly to the chassis.
- 4 Slide the rear-stand assembly towards the bottom of the computer and lift it away from the chassis.

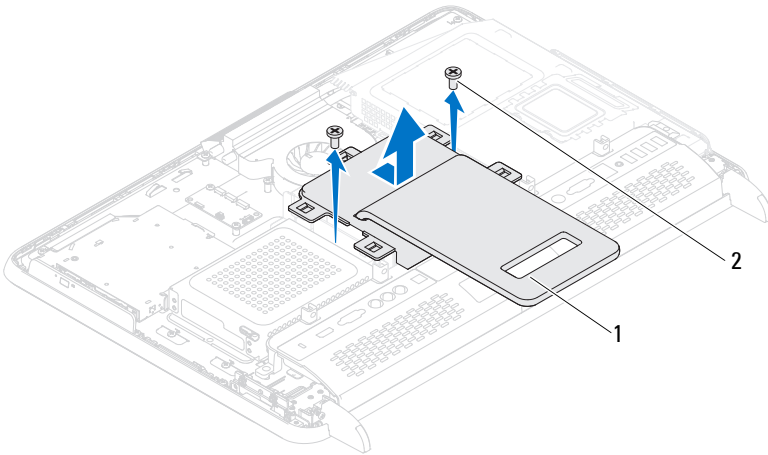

1 rear-stand assembly

2 screws (2)

## Replacing the Rear-Stand Assembly



- 1 Follow the instructions in "Before You Begin" on page 11.
- 2 Place the rear-stand assembly on the chassis and slide it to the top of the computer.
- 3 Replace the two screws that secure the rear-stand assembly to the chassis.
- 4 Replace the back cover. See "Replacing the Back Cover" on page 21.



**CAUTION: Before turning on the computer, replace all screws and ensure that no stray screws remain inside the computer. Failure to do so may result in damage to the computer.**

- 5 Connect your computer and all attached devices to electrical outlets, and turn them on.

## VESA Mount

-  **WARNING:** Before working inside your computer, read the safety information that shipped with your computer. For additional safety best practices information, see the Regulatory Compliance Homepage at [dell.com/regulatory\\_compliance](http://dell.com/regulatory_compliance).
-  **CAUTION:** Only a certified service technician should perform repairs on your computer. Damage due to servicing that is not authorized by Dell is not covered by your warranty.
-  **CAUTION:** To avoid electrostatic discharge, ground yourself by using a wrist grounding strap or by periodically touching an unpainted metal surface (such as a connector on your computer).

## Removing the VESA Mount

- 1 Follow the instructions in "Before You Begin" on page 11.
- 2 Remove the back cover. See "Removing the Back Cover" on page 19.
- 3 Remove the rear-stand assembly. See "Removing the Rear-Stand Assembly" on page 35.
- 4 Remove the six screws that secure the VESA mount to the chassis.

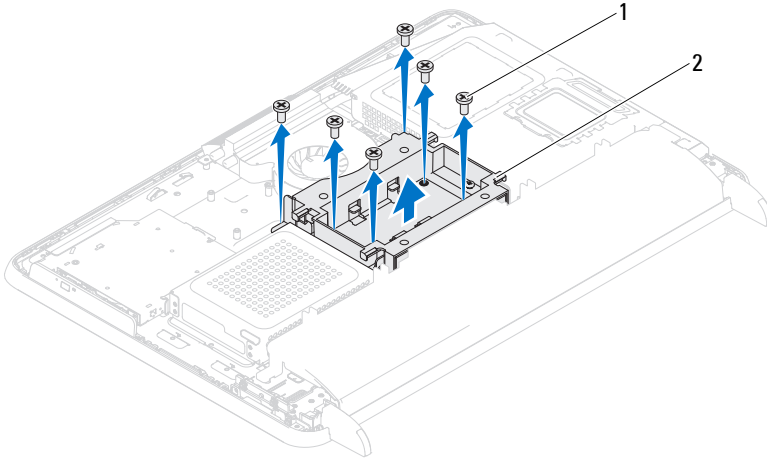

1 screws (6)

2 VESA mount

- 5 Lift the VESA mount away from the chassis.



## Replacing the VESA Mount

- 1 Follow the instructions in "Before You Begin" on page 11.
- 2 Align the screw holes on the VESA mount with the screw holes on the chassis and place the VESA mount on the chassis.
- 3 Replace the six screws that secure the VESA mount to the chassis.
- 4 Replace the rear-stand assembly. See "Replacing the Rear-Stand Assembly" on page 36.
- 5 Replace the back cover. See "Replacing the Back Cover" on page 21.

**⚠ CAUTION: Before turning on the computer, replace all screws and ensure that no stray screws remain inside the computer. Failure to do so may result in damage to the computer.**

- 6 Connect your computer and all attached devices to electrical outlets, and turn them on.

## I/O Cover

-  **WARNING:** Before working inside your computer, read the safety information that shipped with your computer. For additional safety best practices information, see the Regulatory Compliance Homepage at [dell.com/regulatory\\_compliance](http://dell.com/regulatory_compliance).
-  **CAUTION:** Only a certified service technician should perform repairs on your computer. Damage due to servicing that is not authorized by Dell is not covered by your warranty.
-  **CAUTION:** To avoid electrostatic discharge, ground yourself by using a wrist grounding strap or by periodically touching an unpainted metal surface (such as a connector on your computer).

## Rear I/O Cover

### Removing the Rear I/O Cover

- 1 Follow the instructions in "Before You Begin" on page 11.
- 2 Remove the back cover. See "Removing the Back Cover" on page 19.
- 3 Remove the rear-stand assembly. See "Removing the Rear-Stand Assembly" on page 35.
- 4 Remove the four screws that secure the rear I/O cover to the chassis.
- 5 Lift the rear I/O cover away from the chassis.

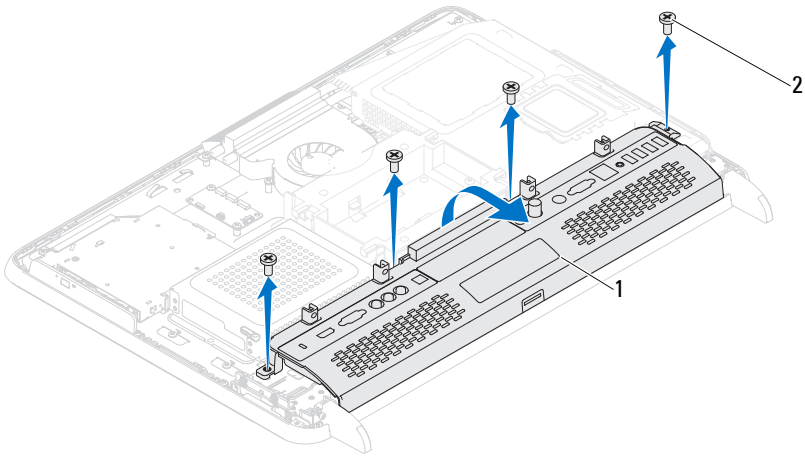

1 rear I/O cover

2 screws (4)

## Replacing the Rear I/O Cover

- 1 Follow the instructions in "Before You Begin" on page 11.
- 2 Align the screw holes on the rear I/O cover with the screw holes on the chassis.
- 3 Replace the four screws that secure the rear I/O cover to the chassis.
- 4 Replace the rear-stand assembly. See "Replacing the Rear-Stand Assembly" on page 36.
- 5 Replace the back cover. See "Replacing the Back Cover" on page 21.



**CAUTION: Before turning on the computer, replace all screws and ensure that no stray screws remain inside the computer. Failure to do so may result in damage to the computer.**

- 6 Connect your computer and all attached devices to electrical outlets, and turn them on.



# Side I/O Cover

## Removing the Side I/O Cover

- 1 Follow the instructions in "Before You Begin" on page 11.
- 2 Remove the back cover. See "Removing the Back Cover" on page 19.
- 3 Pry out and remove the side I/O cover.

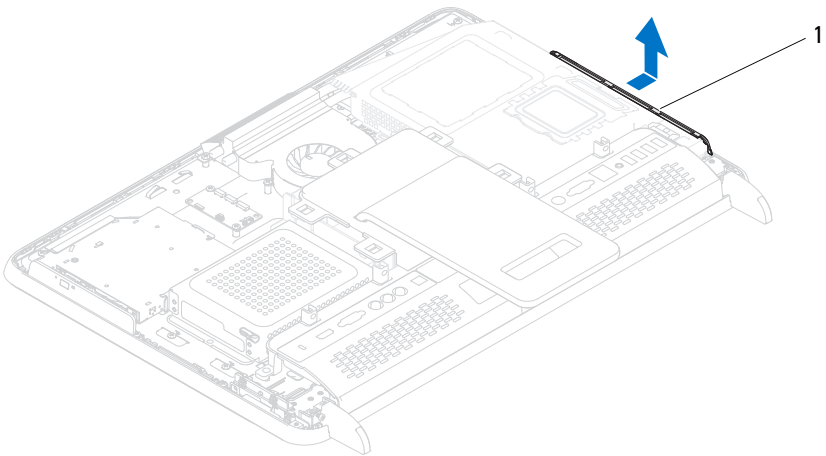

- 1 side I/O cover

## Replacing the Side I/O Cover

- 1 Follow the instructions in "Before You Begin" on page 11.
- 2 Align the side I/O cover with the I/O connectors on the side of the chassis and place the side I/O cover on the chassis.
- 3 Replace the back cover. See "Replacing the Back Cover" on page 21.





**CAUTION: Before turning on the computer, replace all screws and ensure that no stray screws remain inside the computer. Failure to do so may result in damage to the computer.**

- 4 Connect your computer and all attached devices to electrical outlets, and turn them on.



## Audio Video Board (Optional)

-  **WARNING:** Before working inside your computer, read the safety information that shipped with your computer. For additional safety best practices information, see the Regulatory Compliance Homepage at [dell.com/regulatory\\_compliance](http://dell.com/regulatory_compliance).
-  **CAUTION:** Only a certified service technician should perform repairs on your computer. Damage due to servicing that is not authorized by Dell is not covered by your warranty.
-  **CAUTION:** To avoid electrostatic discharge, ground yourself by using a wrist grounding strap or by periodically touching an unpainted metal surface (such as a connector on your computer).

### Removing the Audio Video (AV) Board

- 1 Follow the instructions in "Before You Begin" on page 11.
- 2 Remove the back cover. See "Removing the Back Cover" on page 19.
- 3 Remove the rear-stand assembly. See "Removing the Rear-Stand Assembly" on page 35.
- 4 Remove the rear I/O cover. See "Removing the Rear I/O Cover" on page 39.
- 5 Remove the three screws that secure the AV-board shield to the chassis.
- 6 Lift the AV-board shield away from the AV board.

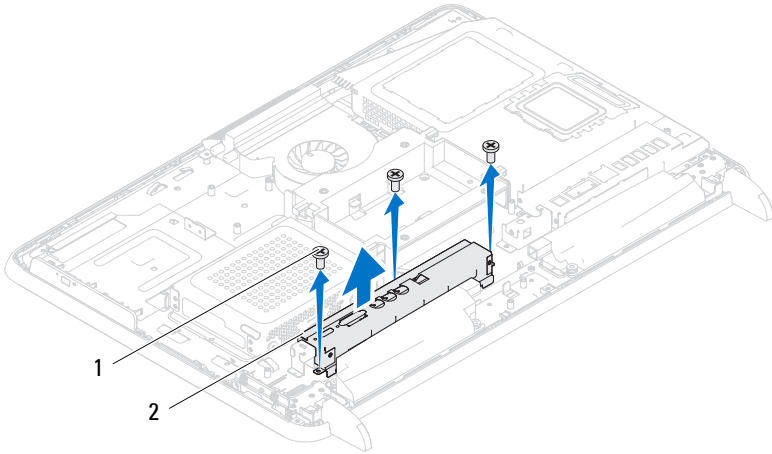

1 screws (3)

2 AV-board shield

- 7 Disconnect the AV-board cables from the connectors on the AV board.
- 8 Remove the five screws that secure the AV board to the chassis.
- 9 Lift the AV board away from the chassis.

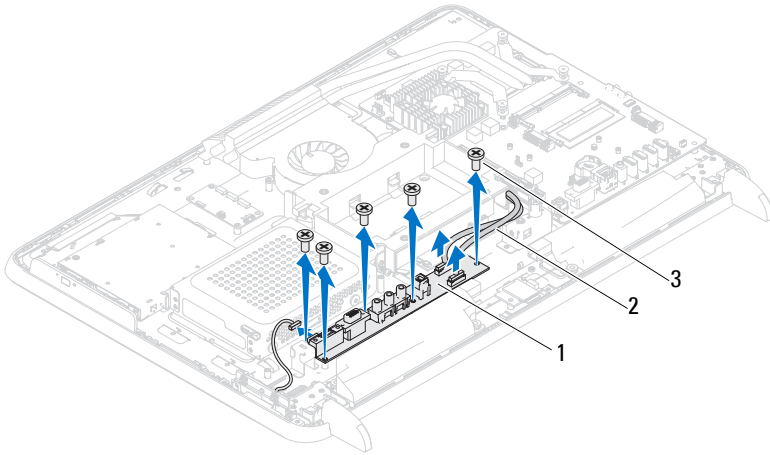

- 1 AV board
- 2 AV-board cables (2)
- 3 screws (5)

## Replacing the Audio Video (AV) Board



- 1 Follow the instructions in "Before You Begin" on page 11.
- 2 Align the screw holes on the AV board with the screw holes on the chassis.
- 3 Replace the five screws that secure the AV board to the chassis.
- 4 Connect the AV-board cables to the connectors on the AV board.
- 5 Replace the rear I/O cover. See "Replacing the Rear I/O Cover" on page 40.
- 6 Replace the rear-stand assembly. See "Replacing the Rear-Stand Assembly" on page 36.
- 7 Replace the back cover. See "Replacing the Back Cover" on page 21.

**⚠ CAUTION: Before turning on the computer, replace all screws and ensure that no stray screws remain inside the computer. Failure to do so may result in damage to the computer.**

- 8 Connect your computer and all attached devices to electrical outlets, and turn them on.



## Converter Board

-  **WARNING:** Before working inside your computer, read the safety information that shipped with your computer. For additional safety best practices information, see the Regulatory Compliance Homepage at [dell.com/regulatory\\_compliance](http://dell.com/regulatory_compliance).
-  **CAUTION:** Only a certified service technician should perform repairs on your computer. Damage due to servicing that is not authorized by Dell is not covered by your warranty.
-  **CAUTION:** To avoid electrostatic discharge, ground yourself by using a wrist grounding strap or by periodically touching an unpainted metal surface (such as a connector on your computer).

## Removing the Converter Board

- 1 Follow the instructions in "Before You Begin" on page 11.
- 2 Remove the back cover. See "Removing the Back Cover" on page 19.
- 3 Remove the rear-stand assembly. See "Removing the Rear-Stand Assembly" on page 35.
- 4 Remove the VESA mount. See "Removing the VESA Mount" on page 37.
- 5 Remove the rear I/O cover. See "Removing the Rear I/O Cover" on page 39.
- 6 Disconnect the converter-board cable from the connector on the converter board.
- 7 Remove the two screws that secure the converter board to the chassis.
- 8 Lift the converter board away from the chassis.

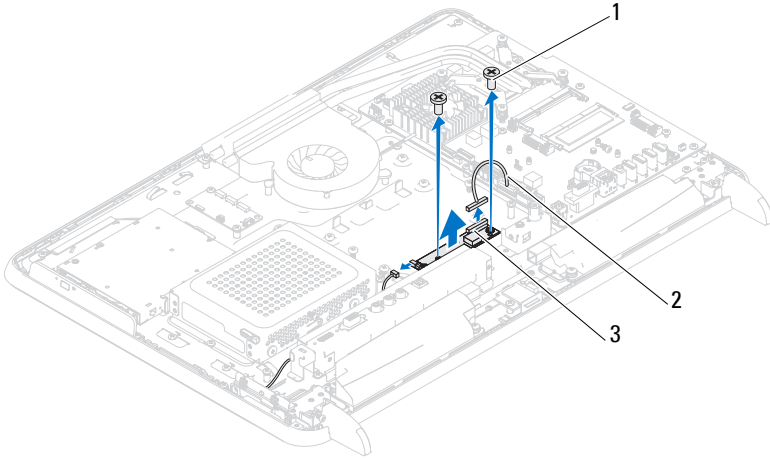

- 1 screws (2)
- 2 converter-board cable
- 3 converter-board connector

## Replacing the Converter Board

- 1 Follow the instructions in "Before You Begin" on page 11.
- 2 Align the screw holes on the converter board with the screw holes on the chassis.
- 3 Replace the two screws that secure the converter board to the chassis.
- 4 Connect the converter-board cable to the connector on the converter board.
- 5 Replace the rear I/O cover. See "Replacing the Rear I/O Cover" on page 40.
- 6 Replace the VESA mount. See "Replacing the VESA Mount" on page 38.
- 7 Replace the rear-stand assembly. See "Replacing the Rear-Stand Assembly" on page 36.
- 8 Replace the back cover. See "Replacing the Back Cover" on page 21.





 **CAUTION:** Before turning on the computer, replace all screws and ensure that no stray screws remain inside the computer. Failure to do so may result in damage to the computer.

- 9 Connect your computer and all attached devices to electrical outlets, and turn them on.



## B-CAS Card (Optional)

 **WARNING:** Before working inside your computer, read the safety information that shipped with your computer. For additional safety best practices information, see the Regulatory Compliance Homepage at [www.dell.com/regulatory\\_compliance](http://www.dell.com/regulatory_compliance).

 **CAUTION:** Only a certified service technician should perform repairs on your computer. Damage due to servicing that is not authorized by Dell is not covered by your warranty.

 **CAUTION:** To avoid electrostatic discharge, ground yourself by using a wrist grounding strap or by periodically touching an unpainted metal surface (such as a connector on your computer).

### Removing the B-CAS Card

- 1 Follow the instructions in "Before You Begin" on page 11.
- 2 Remove the back cover. See "Removing the Back Cover" on page 19.
- 3 Remove the rear-stand assembly. See "Removing the Rear-Stand Assembly" on page 35.
- 4 Remove the rear I/O cover. See "Removing the Rear I/O Cover" on page 39.
- 5 Remove the screw that secures the B-CAS card to the chassis.
- 6 Disconnect the B-CAS card cable from the connector on the B-CAS card.
- 7 Lift the B-CAS card away from the computer.

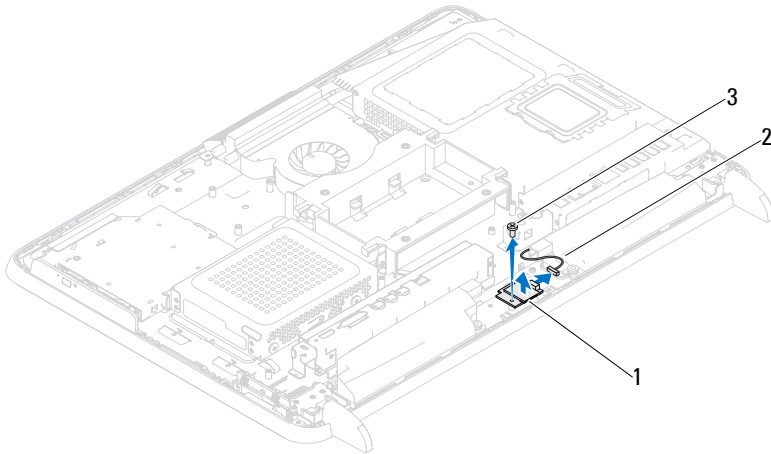

1 B-CAS-card

2 B-CAS card cable

3 screw

## Replacing the B-CAS Card

- 1 Follow the instructions in "Before You Begin" on page 11.
- 2 Connect the B-CAS card cable to the connector on the B-CAS card.
- 3 Align the screw hole on the B-CAS card with the screw hole on the chassis.
- 4 Replace the screw that secures the B-CAS card to the chassis.
- 5 Replace the rear I/O cover. See "Replacing the Rear I/O Cover" on page 40.
- 6 Replace the rear-stand assembly. See "Replacing the Rear-Stand Assembly" on page 36.
- 7 Replace the back cover. See "Replacing the Back Cover" on page 21.





**CAUTION:** Before turning on the computer, replace all screws and ensure that no stray screws remain inside the computer. Failure to do so may result in damage to the computer.

- 8 Connect your computer and all attached devices to electrical outlets, and turn them on.

# System-Board Shield

 **WARNING:** Before working inside your computer, read the safety information that shipped with your computer. For additional safety best practices information, see the Regulatory Compliance Homepage at [dell.com/regulatory\\_compliance](http://dell.com/regulatory_compliance).

 **CAUTION:** Only a certified service technician should perform repairs on your computer. Damage due to servicing that is not authorized by Dell is not covered by your warranty.

 **CAUTION:** To avoid electrostatic discharge, ground yourself by using a wrist grounding strap or by periodically touching an unpainted metal surface (such as a connector on your computer).

## Removing the System-Board Shield

- 1 Follow the instructions in "Before You Begin" on page 11.
- 2 Remove the back cover. See "Removing the Back Cover" on page 19.
- 3 Remove the rear-stand assembly. See "Removing the Rear-Stand Assembly" on page 35.
- 4 Remove the rear I/O cover. See "Removing the Rear I/O Cover" on page 39.
- 5 Remove the side I/O cover. See "Removing the Side I/O Cover" on page 41.
- 6 Remove the five screws that secure the system-board shield to the chassis.

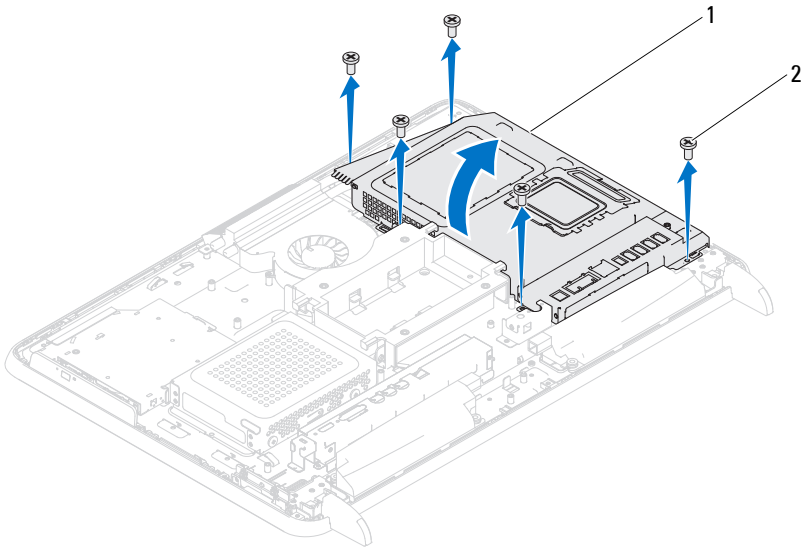

- 1 system-board shield                      2 screws (5)

- 7 Pry away the system-board shield and turn it over to the right of the computer away from the side I/O connectors.

## Replacing the System-Board Shield

- 1 Follow the instructions in "Before You Begin" on page 11.
- 2 Align the system-board shield with the side I/O connectors on the chassis and place the system-board shield over the system board.
- 3 Align the screw holes on the system-board shield with the screw holes on the chassis and replace the five screws that secure the system-board shield to the chassis.
- 4 Replace the side I/O cover. See "Replacing the Side I/O Cover" on page 41.
- 5 Replace the rear I/O cover. See "Replacing the Rear I/O Cover" on page 40.

**6** Replace the rear-stand assembly. See "Replacing the Rear-Stand Assembly" on page 36.

**7** Replace the back cover. See "Replacing the Back Cover" on page 21.





 **CAUTION: Before turning on the computer, replace all screws and ensure that no stray screws remain inside the computer. Failure to do so may result in damage to the computer.**

**8** Connect your computer and all attached devices to electrical outlets, and turn them on.





## Coin-Cell Battery

-  **WARNING:** Before working inside your computer, read the safety information that shipped with your computer. For additional safety best practices information, see the Regulatory Compliance Homepage at [dell.com/regulatory\\_compliance](http://dell.com/regulatory_compliance).
-  **WARNING:** A new battery can explode if it is incorrectly installed. Replace the battery only with the same or equivalent type recommended by the manufacturer. Discard used batteries according to the manufacturer's instructions.
-  **CAUTION:** Only a certified service technician should perform repairs on your computer. Damage due to servicing that is not authorized by Dell is not covered by your warranty.
-  **CAUTION:** To avoid electrostatic discharge, ground yourself by using a wrist grounding strap or by periodically touching an unpainted metal surface (such as a connector on your computer).

### Removing the Coin-Cell Battery

- 1 Follow the instructions in "Before You Begin" on page 11 and record all the screens in system setup utility. See "System Setup" on page 125.
- 2 Remove the back cover. See "Removing the Back Cover" on page 19.
- 3 Remove the rear-stand assembly. See "Removing the Rear-Stand Assembly" on page 35.
- 4 Remove the rear I/O cover. See "Removing the Rear I/O Cover" on page 39.
- 5 Remove the side I/O cover. See "Removing the Side I/O Cover" on page 41.
- 6 Remove the system-board shield. See "Removing the System-Board Shield" on page 53.
- 7 Locate the battery socket. See "System Board Components" on page 17.

**CAUTION:** If you pry the battery out of its socket with a blunt object, be careful not to touch the system board with the object. Ensure that the object is inserted between the battery and the socket before you attempt to pry out the battery. Otherwise, you may damage the system board by prying off the socket or by breaking circuit traces on the system board.

8 Press the battery release lever to remove the battery.

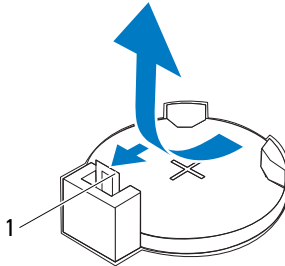

1 battery release lever

## Replacing the Coin-Cell Battery

- 1 Follow the instructions in "Before You Begin" on page 11.
- 2 Insert the new battery (CR2032) into the socket with the side labeled + facing up, and press the battery into place.

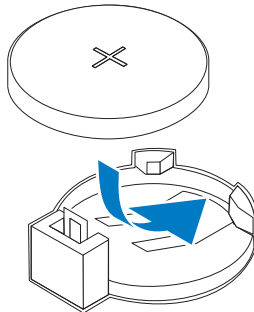

- 3 Replace the system-board shield. "Replacing the System-Board Shield" on page 54.

- 4 Replace the rear I/O cover. See "Replacing the Rear I/O Cover" on page 40.
- 5 Replace the side I/O cover. See "Replacing the Side I/O Cover" on page 41.
- 6 Replace the rear-stand assembly. See "Replacing the Rear-Stand Assembly" on page 36.
- 7 Replace the back cover. See "Replacing the Back Cover" on page 21.



**CAUTION: Before turning on the computer, replace all screws and ensure that no stray screws remain inside the computer. Failure to do so may result in damage to the computer.**

- 8 Connect your computer and devices to electrical outlets, and then turn them on.
- 9 Enter the system setup and restore the settings you recorded in step 1. See "System Setup" on page 125.



## Wireless Mini-Card(s)



**WARNING:** Before working inside your computer, read the safety information that shipped with your computer. For additional safety best practices information, see the Regulatory Compliance Homepage at [dell.com/regulatory\\_compliance](http://dell.com/regulatory_compliance).



**CAUTION:** Only a certified service technician should perform repairs on your computer. Damage due to servicing that is not authorized by Dell is not covered by your warranty.



**CAUTION:** To avoid electrostatic discharge, ground yourself by using a wrist grounding strap or by periodically touching an unpainted metal surface (such as a connector on your computer).



**CAUTION:** When the Mini-Card is not in the computer, store it in protective antistatic packaging (see "Protecting Against Electrostatic Discharge" in the safety instructions that shipped with your computer).



**NOTE:** Dell does not guarantee compatibility or provide support for Mini-Cards from sources other than Dell.

If you ordered a wireless Mini-Card with your computer, the card is already installed.

Your computer supports two full-size Mini-Card slots for Wireless Local Area Network (WLAN) and a TV tuner module.

## Removing the Mini-Card(s)

- 1 Follow the instructions in "Before You Begin" on page 11.
- 2 Remove the back cover. See "Removing the Back Cover" on page 19.
- 3 Remove the rear-stand assembly. See "Removing the Rear-Stand Assembly" on page 35.
- 4 Remove the rear I/O cover. See "Removing the Rear I/O Cover" on page 39.
- 5 Remove the side I/O cover. See "Removing the Side I/O Cover" on page 41.

- 6 Remove the system-board shield. See "Removing the System-Board Shield" on page 53.
- 7 Disconnect the antenna cable(s) from each Mini-Card.

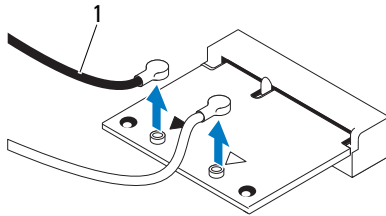

1 antenna cables (2)

- 8 Remove the two screws that secure each Mini-Card to the system-board connector.
- 9 Lift the Mini-Card(s) away from the system-board connector.

**CAUTION:** When the Mini-Card is not in the computer, store it in protective antistatic packaging (see "Protecting Against Electrostatic Discharge" in the safety instructions that shipped with your computer).

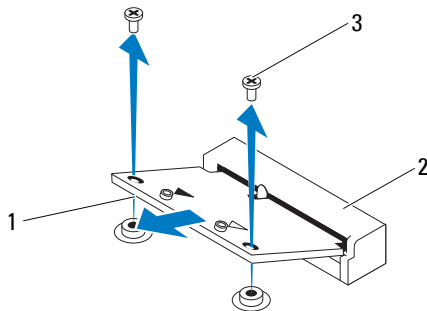

1 Mini-Card  
3 screws (2)

2 system-board connector

## Replacing the Mini-Card(s)

 **CAUTION:** The connectors are keyed to ensure correct insertion. Use of excessive force may damage the connectors.

 **CAUTION:** To avoid damage to the Mini-Card, ensure that there are no cables or antenna cables under the Mini-Card.

- 1 Follow the instructions in "Before You Begin" on page 11.
- 2 Align the notch on each Mini-Card with the tab in the system-board connector.
- 3 Insert the Mini-Card at a 45-degree angle into the system-board connector.
- 4 Press the other end of the Mini-Card down and replace the two screws that secure the Mini-Card to the system-board connector.
- 5 Connect the appropriate antenna cable(s) to the Mini-Card you are installing. The following table provides the antenna cable color scheme for the Mini-Card(s) supported by your computer.

Connectors on the Mini-Card	Antenna Cable Color Scheme
WLAN (2 antenna cables)	
Main WLAN (white triangle)	white
Auxiliary WLAN (black triangle)	black
TV tuner (1 antenna cable)	black





- 6 Replace the system-board shield. "Replacing the System-Board Shield" on page 54.
- 7 Replace the rear I/O cover. See "Replacing the Rear I/O Cover" on page 40.
- 8 Replace the side I/O cover. See "Replacing the Side I/O Cover" on page 41.
- 9 Replace the rear-stand assembly. See "Replacing the Rear-Stand Assembly" on page 36.
- 10 Replace the back cover. See "Replacing the Back Cover" on page 21.

 **CAUTION:** Before turning on the computer, replace all screws and ensure that no stray screws remain inside the computer. Failure to do so may result in damage to the computer.

- 11** Connect your computer and all attached devices to electrical outlets, and turn them on.



# System Board

-  **WARNING:** Before working inside your computer, read the safety information that shipped with your computer. For additional safety best practices information, see the Regulatory Compliance Homepage at [dell.com/regulatory\\_compliance](http://dell.com/regulatory_compliance).
-  **CAUTION:** Only a certified service technician should perform repairs on your computer. Damage due to servicing that is not authorized by Dell is not covered by your warranty.
-  **CAUTION:** To avoid electrostatic discharge, ground yourself by using a wrist grounding strap or by periodically touching an unpainted metal surface (such as a connector on your computer).
-  **CAUTION:** Handle components and cards by their edges, and avoid touching pins and contacts.

## Removing the System Board

- 1 Follow the instructions in "Before You Begin" on page 11.
  - 2 Remove the back cover. See "Removing the Back Cover" on page 19.
  - 3 Remove the rear-stand assembly. See "Removing the Rear-Stand Assembly" on page 35.
  - 4 Remove the rear I/O cover. See "Removing the Rear I/O Cover" on page 39.
  - 5 Remove the side I/O cover. See "Removing the Side I/O Cover" on page 41.
  - 6 Remove the system-board shield. See "Removing the System-Board Shield" on page 53.
  - 7 Remove the memory module(s). See "Removing Memory Module(s)" on page 31.
  - 8 Remove the Mini-Card(s). See "Removing the Mini-Card(s)" on page 61.
  - 9 Remove the processor heat-sink. See "Removing the Processor Heat-Sink" on page 79.
  - 10 Remove the processor. See "Removing the Processor" on page 83.
-  **NOTE:** Record the cable routing before disconnecting the cables from the system board.

- 11 Disconnect all the cables connected to the system board.
- 12 Remove the eight screws that secure the system board to the chassis.
- 13 Lift the system board away from the computer and out of the chassis.

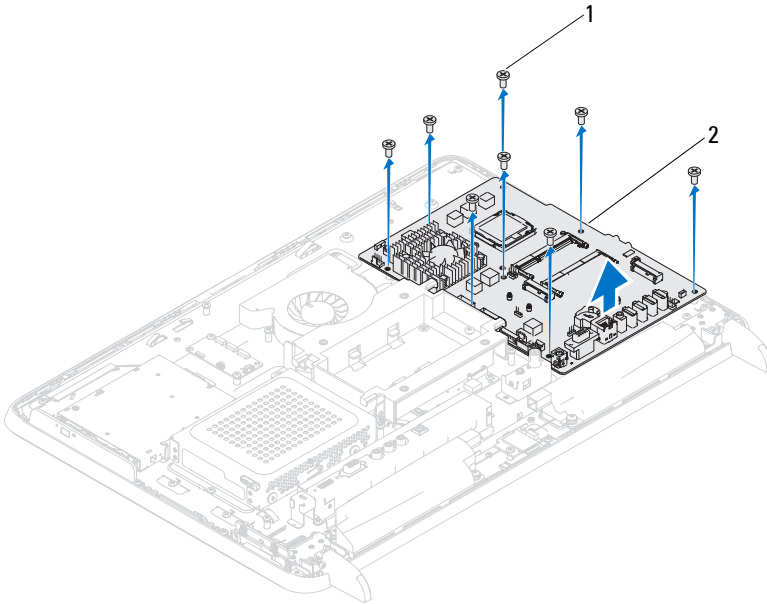



1 screws (8)

2 system board

## Replacing the System Board

- 1 Follow the instructions in "Before You Begin" on page 11.
- 2 Align the screw holes on the system board with the screw holes on the chassis.
- 3 Replace the eight screws that secure the system board to the chassis.
- 4 Connect all the required cables to the system board.
- 5 Replace the processor. See "Replacing the Processor" on page 84.
- 6 Replace the processor heat-sink. See "Replacing the Processor Heat-Sink" on page 80.

- 7 Replace the Mini-Card(s). See "Replacing the Mini-Card(s)" on page 63.
  - 8 Replace the memory module(s). See "Replacing Memory Module(s)" on page 33.
  - 9 Replace the system-board shield. See "Replacing the System-Board Shield" on page 54.
  - 10 Replace the rear I/O cover. See "Replacing the Rear I/O Cover" on page 40.
  - 11 Replace the side I/O cover. See "Replacing the Side I/O Cover" on page 41.
  - 12 Replace the rear-stand assembly. See "Replacing the Rear-Stand Assembly" on page 36.
  - 13 Replace the back cover. See "Replacing the Back Cover" on page 21.
-  **CAUTION:** Before turning on the computer, replace all screws and ensure that no stray screws remain inside the computer. Failure to do so may result in damage to the computer.
- 14 Turn on the computer.
-  **NOTE:** After you have replaced the system board, enter the computer's Service Tag in the BIOS of the replacement system board.
- 15 Enter the Service Tag. See "Entering the Service Tag in the BIOS" on page 67.

## Entering the Service Tag in the BIOS

- 1 Turn on the computer.
- 2 Press <F2> during POST to enter the system setup program.
- 3 Navigate to the main tab and enter the service tag in the **Service Tag Setting** field.



## Feet

- !** **WARNING:** Before working inside your computer, read the safety information that shipped with your computer. For additional safety best practices information, see the Regulatory Compliance Homepage at [dell.com/regulatory\\_compliance](http://dell.com/regulatory_compliance).
- △** **CAUTION:** Only a certified service technician should perform repairs on your computer. Damage due to servicing that is not authorized by Dell is not covered by your warranty.
- △** **CAUTION:** To avoid electrostatic discharge, ground yourself by using a wrist grounding strap or by periodically touching an unpainted metal surface (such as a connector on your computer).

## Removing the Feet

- 1 Follow the instructions in "Before You Begin" on page 11.
- 2 Remove the back cover. See "Removing the Back Cover" on page 19.
- 3 Remove the four screws (two on each foot) that secure the feet to the chassis.

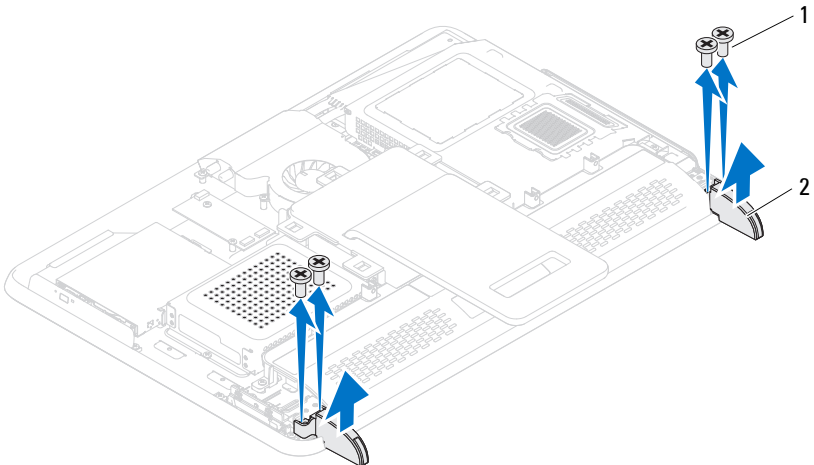

1 screws (4)

2 feet (2)

4 Lift the feet away from the chassis.

## Replacing the Feet

1 Follow the instructions in "Before You Begin" on page 11.

2 Align the screw holes on the feet with the screw holes on the chassis and place the feet on the chassis.

3 Replace the four screws (two on each foot) that secure the feet to the chassis.



4 Replace the back cover. See "Replacing the Back Cover" on page 21.



**CAUTION: Before turning on the computer, replace all screws and ensure that no stray screws remain inside the computer. Failure to do so may result in damage to the computer.**

5 Connect your computer and all attached devices to electrical outlets, and turn them on.

## Middle Frame

-  **WARNING:** Before working inside your computer, read the safety information that shipped with your computer. For additional safety best practices information, see the Regulatory Compliance Homepage at [dell.com/regulatory\\_compliance](http://dell.com/regulatory_compliance).
-  **CAUTION:** Only a certified service technician should perform repairs on your computer. Damage due to servicing that is not authorized by Dell is not covered by your warranty.
-  **CAUTION:** To avoid electrostatic discharge, ground yourself by using a wrist grounding strap or by periodically touching an unpainted metal surface (such as a connector on your computer).

## Removing the Middle Frame

- 1 Follow the instructions in "Before You Begin" on page 11.
- 2 Remove the back cover. See "Removing the Back Cover" on page 19.
- 3 Remove the rear-stand assembly. See "Removing the Rear-Stand Assembly" on page 35.
- 4 Remove the rear I/O cover. See "Removing the Rear I/O Cover" on page 39.
- 5 Remove the side I/O cover. See "Removing the Side I/O Cover" on page 41.
- 6 Remove the system-board shield. See "Removing the System-Board Shield" on page 53.
- 7 Follow the instructions from step 3 to step 5 in "Removing the Optical Drive" on page 27.
- 8 Remove the feet. See "Removing the Feet" on page 69.
- 9 Remove the 11 screws that secure the middle frame to the chassis.
- 10 Pry the tabs on the middle frame from the chassis and lift the middle frame away from the computer.

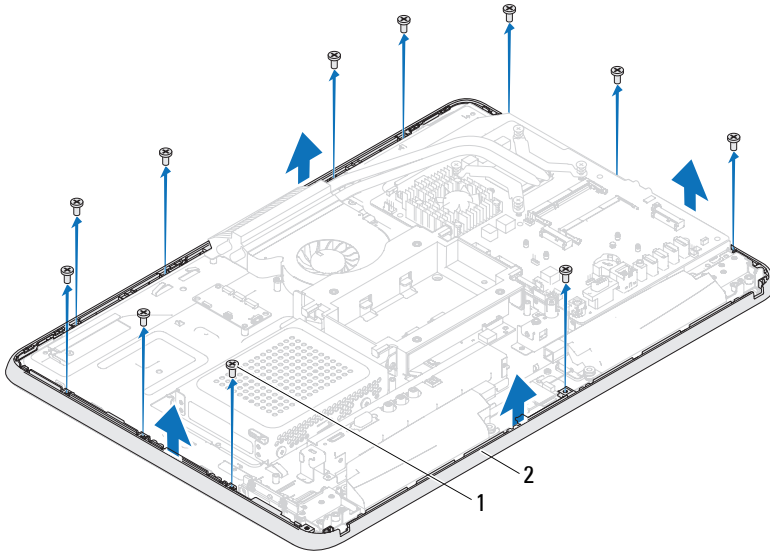

1 screws (11)

2 middle frame

## Replacing the Middle Frame





- 1 Follow the instructions in "Before You Begin" on page 11.
- 2 Align the tabs on the middle frame with the tabs on the chassis.
- 3 Align the screw holes on the middle frame with the screw holes on the chassis.
- 4 Replace the 11 screws that secure the middle frame to the chassis.
- 5 Replace the feet. See "Replacing the Feet" on page 70.
- 6 Follow the instructions from step 4 to step 6 in "Replacing the Optical Drive" on page 29.
- 7 Replace the system-board shield. "Replacing the System-Board Shield" on page 54.
- 8 Replace the rear I/O cover. See "Replacing the Rear I/O Cover" on page 40.
- 9 Replace the side I/O cover. See "Replacing the Side I/O Cover" on page 41.



- 10 Replace the rear-stand assembly. See "Replacing the Rear-Stand Assembly" on page 36.
  - 11 Replace the back cover. See "Replacing the Back Cover" on page 21.
-  **CAUTION: Before turning on the computer, replace all screws and ensure that no stray screws remain inside the computer. Failure to do so may result in damage to the computer.**
- 12 Connect your computer and all attached devices to electrical outlets, and turn them on.



## Processor Heat-Sink Fan

-  **WARNING:** Before working inside your computer, read the safety information that shipped with your computer. For additional safety best practices information, see the Regulatory Compliance Homepage at [dell.com/regulatory\\_compliance](http://dell.com/regulatory_compliance).
-  **WARNING:** The heat sink may be very hot during normal operation. Ensure that it has had sufficient time to cool before you touch it.
-  **CAUTION:** Only a certified service technician should perform repairs on your computer. Damage due to servicing that is not authorized by Dell is not covered by your warranty.
-  **CAUTION:** To avoid electrostatic discharge, ground yourself by using a wrist grounding strap or by periodically touching an unpainted metal surface (such as a connector on your computer).

### Removing the Processor Heat-Sink Fan

- 1 Follow the instructions in "Before You Begin" on page 11.
- 2 Remove the back cover. See "Removing the Back Cover" on page 19.
- 3 Remove the rear-stand assembly. See "Removing the Rear-Stand Assembly" on page 35.
- 4 Remove the VESA mount. See "Removing the VESA Mount" on page 37.
- 5 Remove the rear I/O cover. See "Removing the Rear I/O Cover" on page 39.
- 6 Remove the side I/O cover. See "Removing the Side I/O Cover" on page 41.
- 7 Remove the system-board shield. See "Removing the System-Board Shield" on page 53.
- 8 Disconnect the processor heat-sink fan cable from the connector (CPU FAN) on the system board.
- 9 Remove the three screws that secure the processor heat-sink fan to the chassis.

- 10 Carefully peel the silver foil from the processor heat-sink.
- 11 Lift the processor heat-sink fan along with its cable away from the chassis.

 **NOTE:** The appearance of the system board may vary based on your computer model.

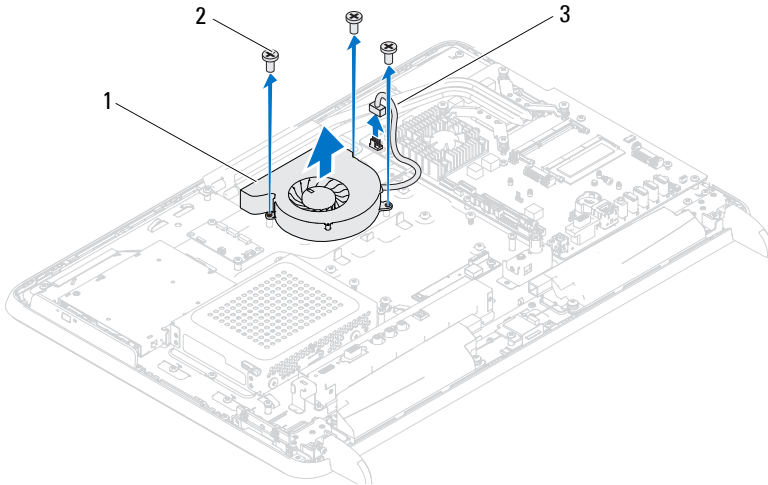

- 1 processor heat-sink fan
- 2 screws (3)
- 3 processor heat-sink fan cable





## Replacing the Processor Heat-Sink Fan

- 1 Follow the instructions in "Before You Begin" on page 11.
- 2 Align the screw holes on the processor heat-sink fan with the screw holes on the chassis.
- 3 Adhere the silver foil on the processor heat-sink.
- 4 Replace the three screws that secure the processor heat-sink fan to the chassis.
- 5 Connect the processor heat-sink fan cable to the connector (CPU FAN) on the system board.

- 6 Replace the system-board shield. See "Replacing the System-Board Shield" on page 54.
  - 7 Replace the rear I/O cover. See "Replacing the Rear I/O Cover" on page 40.
  - 8 Replace the side I/O cover. See "Replacing the Side I/O Cover" on page 41.
  - 9 Replace the VESA mount. See "Replacing the VESA Mount" on page 38.
  - 10 Replace the rear-stand assembly. See "Replacing the Rear-Stand Assembly" on page 36.
  - 11 Replace the back cover. See "Replacing the Back Cover" on page 21.
-  **CAUTION: Before turning on the computer, replace all screws and ensure that no stray screws remain inside the computer. Failure to do so may result in damage to the computer.**
- 12 Connect your computer and all attached devices to electrical outlets, and turn them on.



## Processor Heat-Sink

-  **WARNING:** Before working inside your computer, read the safety information that shipped with your computer. For additional safety best practices information, see the Regulatory Compliance Homepage at [dell.com/regulatory\\_compliance](http://dell.com/regulatory_compliance).
-  **WARNING:** The heat sink may be very hot during normal operation. Ensure that it has had sufficient time to cool before you touch it.
-  **CAUTION:** Only a certified service technician should perform repairs on your computer. Damage due to servicing that is not authorized by Dell is not covered by your warranty.
-  **CAUTION:** To avoid electrostatic discharge, ground yourself by using a wrist grounding strap or by periodically touching an unpainted metal surface (such as a connector on your computer).

## Removing the Processor Heat-Sink

-  **CAUTION:** To ensure maximum cooling for the processor, do not touch the heat transfer areas on the processor heat-sink. The oils in your skin can reduce the heat transfer capability of the thermal grease.
- 1 Follow the instructions in "Before You Begin" on page 11.
  - 2 Remove the back cover. See "Removing the Back Cover" on page 19.
  - 3 Remove the rear-stand assembly. See "Removing the Rear-Stand Assembly" on page 35.
  - 4 Remove the rear I/O cover. See "Removing the Rear I/O Cover" on page 39.
  - 5 Remove the side I/O cover. See "Removing the Side I/O Cover" on page 41.
  - 6 Remove the system-board shield. See "Removing the System-Board Shield" on page 53.
  - 7 Remove the screw that secures the processor heat-sink to the chassis.

- 8 Loosen the four captive screws that secure the processor heat-sink to the system board.
- 9 Carefully lift the processor heat-sink away from the computer.

 **NOTE:** The appearance of the processor heat-sink may vary based on your computer model.

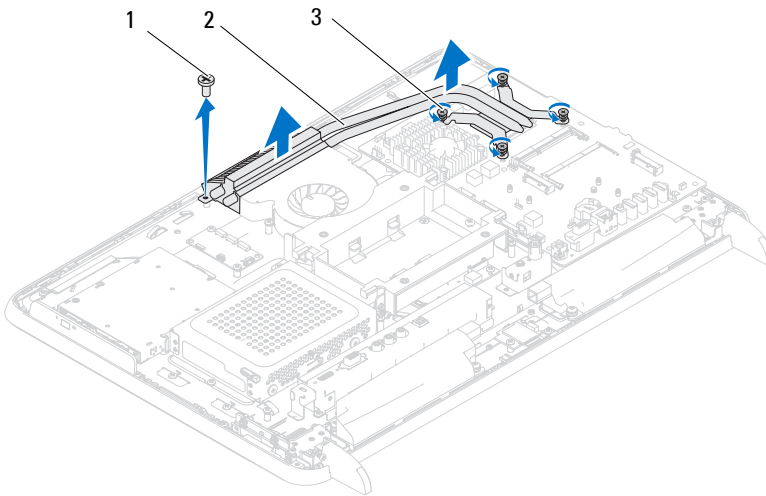

- |   |                    |   |                     |
|---|--------------------|---|---------------------|
| 1 | screw              | 2 | processor heat-sink |
| 3 | captive screws (4) |   |                     |

## Replacing the Processor Heat-Sink

 **CAUTION:** Incorrect alignment of the processor heat-sink can cause damage to the system board and processor.

 **NOTE:** The original thermal grease can be reused if the original processor and processor heat-sink are reinstalled together. If either the processor or the processor heat-sink is replaced, use the thermal grease provided in the kit to ensure that thermal conductivity is achieved.

- 1 Follow the instructions in "Before You Begin" on page 11.



- 2 Clean the thermal grease from the bottom of the processor heat-sink and reapply it.
- 3 Replace the screw that secures the processor heat-sink to the chassis.
- 4 Align the four captive screws on the processor heat-sink with the screw holes on the system board and tighten the screws.
- 5 Replace the system-board shield. See "Replacing the System-Board Shield" on page 54.
- 6 Replace the rear I/O cover. See "Replacing the Rear I/O Cover" on page 40.
- 7 Replace the side I/O cover. See "Replacing the Side I/O Cover" on page 41.
- 8 Replace the rear-stand assembly. See "Replacing the Rear-Stand Assembly" on page 36.
- 9 Replace the back cover. See "Replacing the Back Cover" on page 21.





**CAUTION: Before turning on the computer, replace all screws and ensure that no stray screws remain inside the computer. Failure to do so may result in damage to the computer.**

- 10 Connect your computer and all attached devices to electrical outlets, and turn them on.



## Processor

-  **WARNING:** Before working inside your computer, read the safety information that shipped with your computer. For additional safety best practices information, see the Regulatory Compliance Homepage at [dell.com/regulatory\\_compliance](http://dell.com/regulatory_compliance).
-  **CAUTION:** Only a certified service technician should perform repairs on your computer. Damage due to servicing that is not authorized by Dell is not covered by your warranty.
-  **CAUTION:** To avoid electrostatic discharge, ground yourself by using a wrist grounding strap or by periodically touching an unpainted metal surface (such as a connector on your computer).

## Removing the Processor

- 1 Follow the instructions in "Before You Begin" on page 11.
- 2 Remove the back cover. See "Removing the Back Cover" on page 19.
- 3 Remove the rear-stand assembly. See "Removing the Rear-Stand Assembly" on page 35.
- 4 Remove the rear I/O cover. See "Removing the Rear I/O Cover" on page 39.
- 5 Remove the side I/O cover. See "Removing the Side I/O Cover" on page 41.
- 6 Remove the system-board shield. See "Removing the System-Board Shield" on page 53.
- 7 Remove the processor heat-sink. See "Removing the Processor Heat-Sink" on page 79.
- 8 Press the release lever down on the processor cover and then pull it outwards to release it from the tab that secures it.
- 9 Extend the release lever completely to open the processor cover.  
Leave the release lever extended in the release position so that the socket is ready for the new processor.

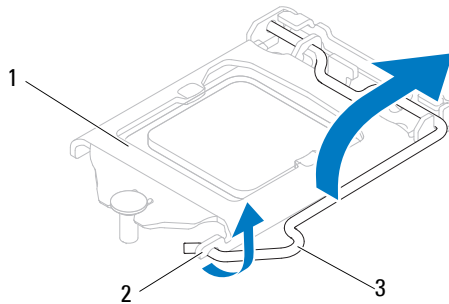

- 1 processor cover
- 2 tab
- 3 release lever

**10** Gently lift the processor to remove it from the socket.

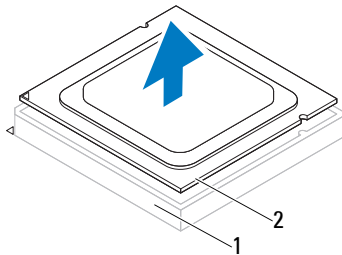

- 1 socket
- 2 processor

## Replacing the Processor

- 1 Follow the instructions in "Before You Begin" on page 11.
- 2 Unpack the new processor, being careful not to touch the underside of the processor.



**CAUTION: Ground yourself by touching an unpainted metal surface or the computer stand.**

- 3 If the release lever on the socket is not fully extended, move it to that position.
- 4 Orient the alignment notches on the processor with the alignment tabs on the socket.
- 5 Align the pin-1 corners of the processor and socket.

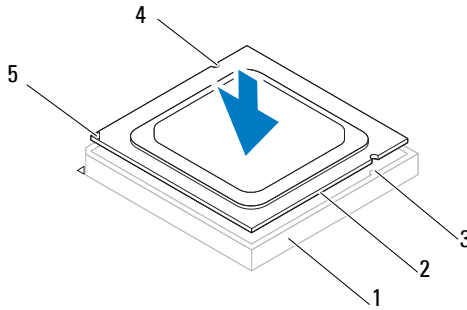

- |   |                           |   |                       |
|---|---------------------------|---|-----------------------|
| 1 | socket                    | 2 | processor             |
| 3 | alignment tabs (2)        | 4 | alignment notches (2) |
| 5 | processor pin-1 indicator |   |                       |

**CAUTION:** Ensure that the processor cover notch is positioned underneath the alignment post.

- 6 When the processor is fully seated in the socket, close the processor cover.
- 7 Pivot the release lever down and place it under the tab on the processor cover.

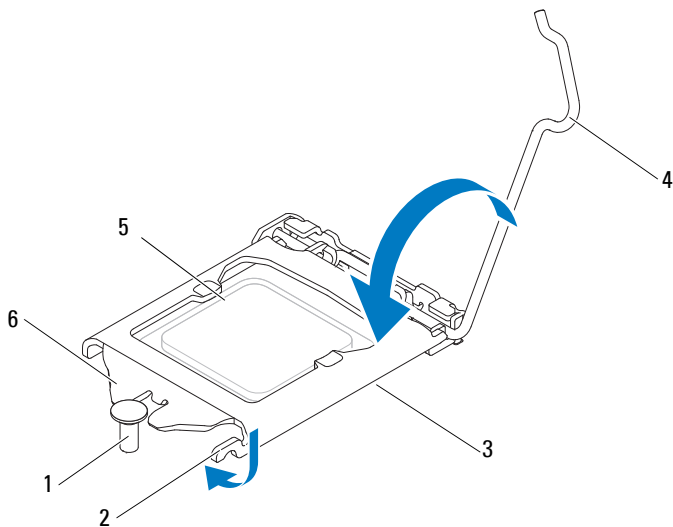

- |   |                 |   |                       |
|---|-----------------|---|-----------------------|
| 1 | alignment post  | 2 | tab                   |
| 3 | processor cover | 4 | release lever         |
| 5 | processor       | 6 | processor cover notch |

**8** Clean the thermal grease from the bottom of the heat sink.

**9** Apply the new thermal grease to the top of the processor.

**CAUTION:** You must position the processor correctly in the processor socket to avoid permanent damage to the processor.

**CAUTION:** Ensure that you apply new thermal grease. New thermal grease is critical for ensuring adequate thermal bonding, which is a requirement for optimal processor operation.

**CAUTION:** Ensure that the processor heat-sink is correctly seated and secure.

**10** Replace the processor heat-sink. See "Replacing the Processor Heat-Sink" on page 80.

**11** Replace the system-board shield. See "Replacing the System-Board Shield" on page 54.

- 12 Replace the rear I/O cover. See "Replacing the Rear I/O Cover" on page 40.
- 13 Replace the side I/O cover. See "Replacing the Side I/O Cover" on page 41.
- 14 Replace the rear-stand assembly. See "Replacing the Rear-Stand Assembly" on page 36.
- 15 Replace the back cover. See "Replacing the Back Cover" on page 21.





**CAUTION: Before turning on the computer, replace all screws and ensure that no stray screws remain inside the computer. Failure to do so may result in damage to the computer.**

- 16 Connect your computer and all attached devices to electrical outlets, and then turn them on.





# Antenna-In Connector

-  **WARNING:** Before working inside your computer, read the safety information that shipped with your computer. For additional safety best practices information, see the Regulatory Compliance Homepage at [www.dell.com/regulatory\\_compliance](http://www.dell.com/regulatory_compliance).
-  **CAUTION:** Only a certified service technician should perform repairs on your computer. Damage due to servicing that is not authorized by Dell is not covered by your warranty.
-  **CAUTION:** To avoid electrostatic discharge, ground yourself by using a wrist grounding strap or by periodically touching an unpainted metal surface (such as a connector on your computer).

## Removing the Antenna-In Connector

- 1 Follow the instructions in "Before You Begin" on page 11.
- 2 Remove the back cover. See "Removing the Back Cover" on page 19.
- 3 Remove the rear-stand assembly. See "Removing the Rear-Stand Assembly" on page 35.
- 4 Remove the rear I/O cover. See "Removing the Rear I/O Cover" on page 39.
- 5 Remove the side I/O cover. See "Removing the Side I/O Cover" on page 41.
- 6 Remove the system-board shield. See "Removing the System-Board Shield" on page 53.
- 7 Remove the two screws that secure the antenna-in connector to the chassis.
- 8 Disconnect the antenna-in cable from the connector on the Mini-Card.
- 9 Slide and lift the antenna-in connector along with its cable away from the chassis.

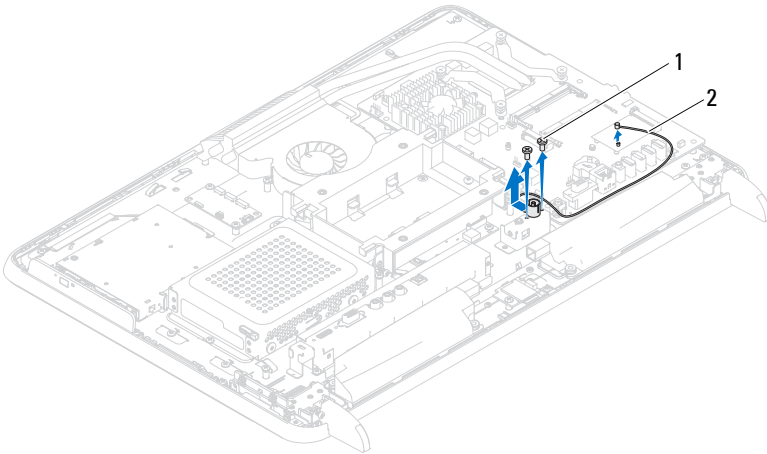

1 screws (2)

2 antenna-in connector cable

## Replacing the Antenna-In Connector

- 1 Follow the instructions in "Before You Begin" on page 11.
- 2 Slide the antenna-in connector into the slot on the chassis.
- 3 Replace the two screws that secure the antenna-in connector to the chassis.
- 4 Connect the antenna-in cable to the connector on the Mini-Card.
- 5 Replace the system-board shield. See "Replacing the System-Board Shield" on page 54.
- 6 Replace the rear I/O cover. See "Replacing the Rear I/O Cover" on page 40.
- 7 Replace the side I/O cover. See "Replacing the Side I/O Cover" on page 41.
- 8 Replace the rear-stand assembly. See "Replacing the Rear-Stand Assembly" on page 36.
- 9 Replace the back cover. See "Replacing the Back Cover" on page 21.





**CAUTION:** Before turning on the computer, replace all screws and ensure that no stray screws remain inside the computer. Failure to do so may result in damage to the computer.

- 10** Connect your computer and all attached devices to electrical outlets, and turn them on.



# Antenna Module

-  **WARNING:** Before working inside your computer, read the safety information that shipped with your computer. For additional safety best practices information, see the Regulatory Compliance Homepage at [dell.com/regulatory\\_compliance](http://dell.com/regulatory_compliance).
-  **CAUTION:** Only a certified service technician should perform repairs on your computer. Damage due to servicing that is not authorized by Dell is not covered by your warranty.
-  **CAUTION:** To avoid electrostatic discharge, ground yourself by using a wrist grounding strap or by periodically touching an unpainted metal surface (such as a connector on your computer).

## Removing the Antenna Module

- 1 Follow the instructions in "Before You Begin" on page 11.
- 2 Remove the back cover. See "Removing the Back Cover" on page 19.
- 3 Remove the rear-stand assembly. See "Removing the Rear-Stand Assembly" on page 35.
- 4 Remove the VESA mount. See "Removing the VESA Mount" on page 37.
- 5 Follow the instructions from step 3 to step 5 in "Removing the Optical Drive" on page 27.
- 6 Remove the rear I/O cover. See "Removing the Rear I/O Cover" on page 39.
- 7 Remove the side I/O cover. See "Removing the Side I/O Cover" on page 41.
- 8 Remove the system-board shield. See "Removing the System-Board Shield" on page 53.
- 9 Remove the middle frame. See "Removing the Middle Frame" on page 71.
- 10 Follow instructions in step 8 to step 11 in "Removing the Processor Heat-Sink Fan" on page 75.
- 11 Disconnect the antenna cables from the connectors on the Mini-Card.
- 12 Remove the four screws that secure the antenna modules to the chassis.
- 13 Make a note of the antenna cable routing and release the antenna cable.

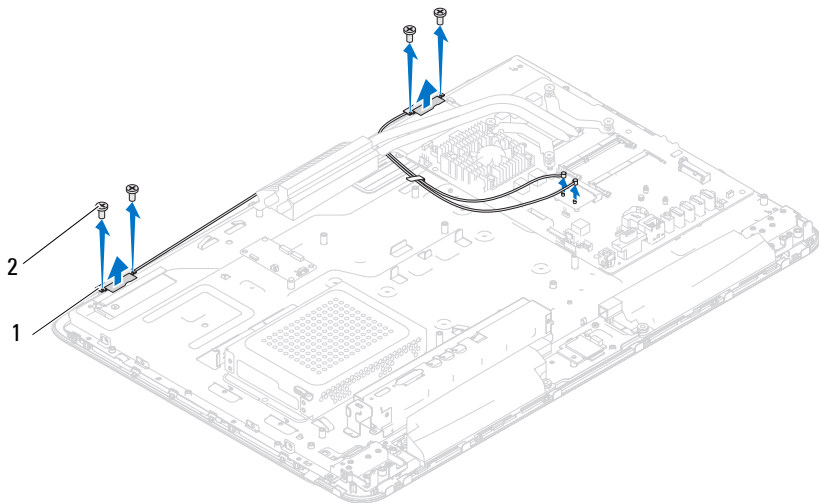

1 antenna modules (2)

2 screws (4)

## Replacing the Antenna Module

- 1 Follow the instructions in "Before You Begin" on page 11.
- 2 Align the screw holes on the antenna modules with the screw holes on the chassis and place the antenna modules on the chassis.
- 3 Replace the four screws that secure the antenna modules to the chassis.
- 4 Route the antenna cables through the routing guides on the chassis.
- 5 Connect the antenna cables to the connectors on the Mini-card.
- 6 Follow the instructions from step 2 to step 5 in "Replacing the Processor Heat-Sink Fan" on page 76.
- 7 Replace the middle frame. See "Replacing the Middle Frame" on page 72.
- 8 Replace the system-board shield. See "Replacing the System-Board Shield" on page 54.
- 9 Replace the rear I/O cover. See "Replacing the Rear I/O Cover" on page 40.
- 10 Replace the side I/O cover. See "Replacing the Side I/O Cover" on page 41.

- 11 Follow the instructions from step 4 to step 6 in "Replacing the Optical Drive" on page 29.
- 12 Replace the VESA mount. See "Replacing the VESA Mount" on page 38.
- 13 Replace the rear-stand assembly. See "Replacing the Rear-Stand Assembly" on page 36.
- 14 Replace the back cover. See "Replacing the Back Cover" on page 21.



**CAUTION: Before turning on the computer, replace all screws and ensure that no stray screws remain inside the computer. Failure to do so may result in damage to the computer.**

- 15 Connect your computer and all attached devices to electrical outlets, and turn them on.





## Power-Button Board

 **WARNING:** Before working inside your computer, read the safety information that shipped with your computer. For additional safety best practices information, see the Regulatory Compliance Homepage at [www.dell.com/regulatory\\_compliance](http://www.dell.com/regulatory_compliance).

 **CAUTION:** Only a certified service technician should perform repairs on your computer. Damage due to servicing that is not authorized by Dell is not covered by your warranty.

 **CAUTION:** To avoid electrostatic discharge, ground yourself by using a wrist grounding strap or by periodically touching an unpainted metal surface (such as a connector on your computer).

## Removing the Power-Button Board

- 1 Follow the instructions in "Before You Begin" on page 11.
- 2 Remove the back cover. See "Removing the Back Cover" on page 19.
- 3 Remove the rear-stand assembly. See "Removing the Rear-Stand Assembly" on page 35.
- 4 Remove the rear I/O cover. See "Removing the Rear I/O Cover" on page 39.
- 5 Remove the side I/O cover. See "Removing the Side I/O Cover" on page 41.
- 6 Remove the system-board shield. See "Removing the System-Board Shield" on page 53.
- 7 Remove the screw that secures the power-button board to the chassis.
- 8 Disconnect the power button and hard-drive activity light cable from the connectors on the power-button board, the AV board, and the system board.
- 9 Slide and lift the power-button board along with its cable away from the chassis.

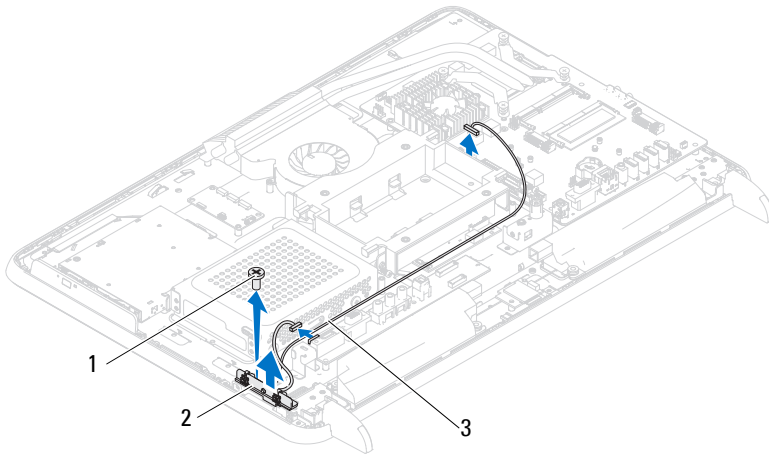

- 1 screw
- 2 power-button board
- 3 power-button and hard-drive activity light cable

## Replacing the Power-Button Board



- 1 Follow the instructions in "Before You Begin" on page 11.
- 2 Align the screw hole on the power-button board with the screw hole on the chassis.
- 3 Replace the screw that secures the power-button board to the chassis.
- 4 Connect the power button and hard-drive activity light cable to the connectors on the power-button board, the AV board, and the system board.
- 5 Replace the system-board shield. See "Replacing the System-Board Shield" on page 54.
- 6 Replace the rear I/O cover. See "Replacing the Rear I/O Cover" on page 40.
- 7 Replace the side I/O cover. See "Replacing the Side I/O Cover" on page 41.
- 8 Replace the rear-stand assembly. See "Replacing the Rear-Stand Assembly" on page 36.
- 9 Replace the back cover. See "Replacing the Back Cover" on page 21.

 **CAUTION:** Before turning on the computer, replace all screws and ensure that no stray screws remain inside the computer. Failure to do so may result in damage to the computer.

- 10** Connect your computer and all attached devices to electrical outlets, and turn them on.



# Speakers

-  **WARNING:** Before working inside your computer, read the safety information that shipped with your computer. For additional safety best practices information, see the Regulatory Compliance Homepage at [dell.com/regulatory\\_compliance](http://dell.com/regulatory_compliance).
-  **CAUTION:** Only a certified service technician should perform repairs on your computer. Damage due to servicing that is not authorized by Dell is not covered by your warranty.
-  **CAUTION:** To avoid electrostatic discharge, ground yourself by using a wrist grounding strap or by periodically touching an unpainted metal surface (such as a connector on your computer).

## Removing the Speakers

- 1 Follow the instructions in "Before You Begin" on page 11.
- 2 Remove the back cover. See "Removing the Back Cover" on page 19.
- 3 Remove the rear-stand assembly. See "Removing the Rear-Stand Assembly" on page 35.
- 4 Remove the rear I/O cover. See "Removing the Rear I/O Cover" on page 39.
- 5 Remove the side I/O cover. See "Removing the Side I/O Cover" on page 41.
- 6 Remove the system-board shield. See "Removing the System-Board Shield" on page 53.
- 7 Disconnect the speakers cable from the connector on the system board.
- 8 Make note of the speakers cable routing and release the cable.
- 9 Remove the four screws (two on each speaker) that secure the speakers to the chassis.
- 10 Lift the speakers along with the cable off the chassis.



**NOTE:** The appearance of the system board may vary based on your computer model

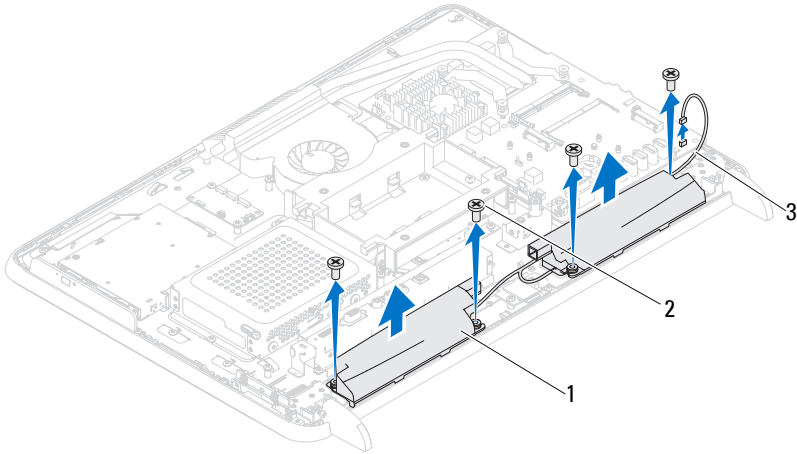

1 speakers (2)

2 screws (4)

3 speakers cable

## Replacing the Speakers

- 1 Follow the instructions in "Before You Begin" on page 11.
- 2 Align the screw holes on the speakers with the screw holes on the chassis.
- 3 Replace the four screws (two on each speaker) that secure the speakers to the chassis.
- 4 Route the speakers cable and connect the speakers cable to the connector on the system board.
- 5 Replace the system-board shield. See "Replacing the System-Board Shield" on page 54.
- 6 Replace the rear I/O cover. See "Replacing the Rear I/O Cover" on page 40.
- 7 Replace the side I/O cover. See "Replacing the Side I/O Cover" on page 41.
- 8 Replace the rear-stand assembly. See "Replacing the Rear-Stand Assembly" on page 36.
- 9 Replace the back cover. See "Replacing the Back Cover" on page 21.



 **CAUTION:** Before turning on the computer, replace all screws and ensure that no stray screws remain inside the computer. Failure to do so may result in damage to the computer.

- 10** Connect your computer and all attached devices to electrical outlets, and turn them on.





# Touch-Screen Control Board (Optional)

-  **WARNING:** Before working inside your computer, read the safety information that shipped with your computer. For additional safety best practices information, see the Regulatory Compliance Homepage at [dell.com/regulatory\\_compliance](http://dell.com/regulatory_compliance).
-  **CAUTION:** Only a certified service technician should perform repairs on your computer. Damage due to servicing that is not authorized by Dell is not covered by your warranty.
-  **CAUTION:** To avoid electrostatic discharge, ground yourself by using a wrist grounding strap or by periodically touching an unpainted metal surface (such as a connector on your computer).

## Removing the Touch-Screen Control Board

- 1 Follow the instructions in "Before You Begin" on page 11.
- 2 Remove the back cover. See "Removing the Back Cover" on page 19.
- 3 Disconnect the cables from the connectors on the touch-screen control board.
- 4 Remove the two screws that secure the touch-screen control board to the chassis.
- 5 Lift the touch-screen control board away from the chassis.

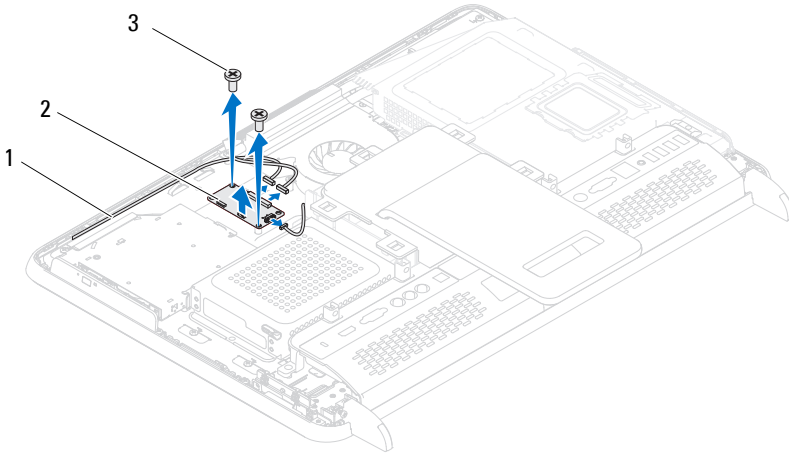

- 1 touch-screen control board
- 2 touch-screen control board cables
- 3 screws (2)

## Replacing the Touch-Screen Control Board

- 1 Follow the instructions in "Before You Begin" on page 11.
- 2 Align the screw holes on the touch-screen control board with the screw holes on the chassis.
- 3 Replace the two screws that secure the touch-screen control board to the chassis.
- 4 Connect the cables to the connectors on the touch-screen control board.
- 5 Replace the back cover. See "Replacing the Back Cover" on page 21.





**CAUTION:** Before turning on the computer, replace all screws and ensure that no stray screws remain inside the computer. Failure to do so may result in damage to the computer.

- 6 Connect your computer and all attached devices to electrical outlets, and turn them on.



# Display

-  **WARNING:** Before working inside your computer, read the safety information that shipped with your computer. For additional safety best practices information, see the Regulatory Compliance Homepage at [dell.com/regulatory\\_compliance](http://dell.com/regulatory_compliance).
-  **CAUTION:** Only a certified service technician should perform repairs on your computer. Damage due to servicing that is not authorized by Dell is not covered by your warranty.
-  **CAUTION:** To avoid electrostatic discharge, ground yourself by using a wrist grounding strap or by periodically touching an unpainted metal surface (such as a connector on your computer).

## Display Assembly

### Removing the Display Assembly

- 1 Follow the instructions in "Before You Begin" on page 11.
- 2 Remove the back cover. See "Removing the Back Cover" on page 19.
- 3 Remove the rear-stand assembly. See "Removing the Rear-Stand Assembly" on page 35.
- 4 Remove the feet. See "Removing the Feet" on page 69.
- 5 Follow the instructions from step 3 to step 5 in "Removing the Optical Drive" on page 27.
- 6 Remove the VESA mount. See "Removing the VESA Mount" on page 37.
- 7 Remove the rear I/O cover. See "Removing the Rear I/O Cover" on page 39.
- 8 Remove the side I/O cover. See "Removing the Side I/O Cover" on page 41.
- 9 Remove the system-board shield. See "Removing the System-Board Shield" on page 53.
- 10 Remove the AV board. See "Removing the Audio Video (AV) Board" on page 43.
- 11 Remove the processor heat-sink fan. See "Removing the Processor Heat-Sink Fan" on page 75.

**12** Make a note of the camera cables, touch-screen control board cables, backlight cable, and LVDS cable routing.

 **NOTE:** The location of the LVDS connector may vary depending on the computer configuration.

**13** Disconnect the cables from the connectors on the system board, touch-screen control board, AV board, and the converter board.

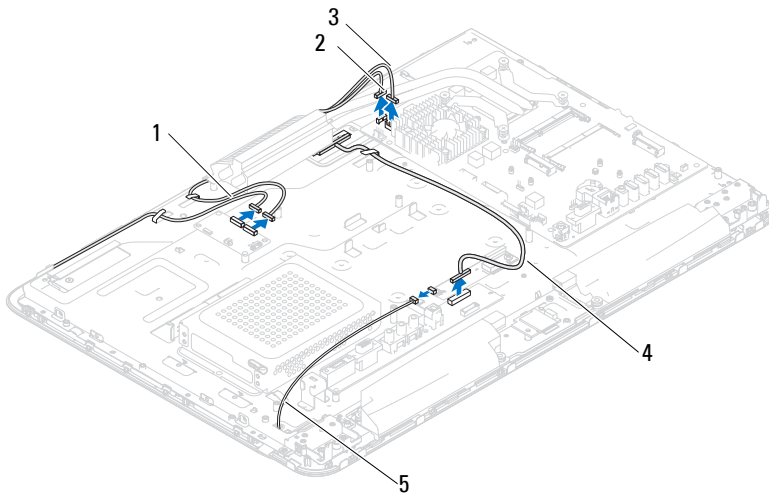

- |  |                |
|--|----------------|
| 1 touch-screen control board cables (optional) (2) | 2 camera cable |
| 3 IR receiver cable (optional)                     | 4 LVDS cable   |
| 5 backlight cable                                  |                |

**14** Remove the middle frame. See "Removing the Middle Frame" on page 71.

**15** Remove the five screws that secure the chassis to the display assembly.

**16** Remove the 13 screws that secure the chassis to the display bezel.

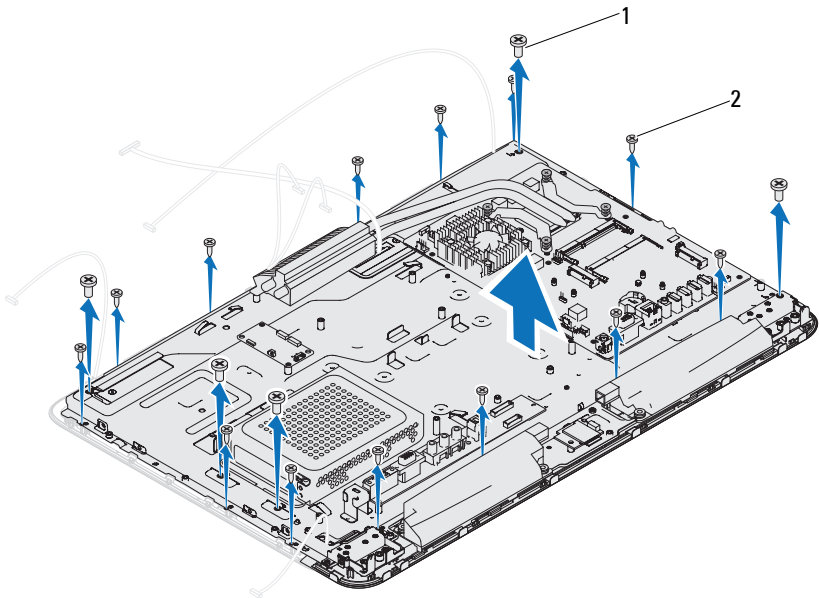

1 screws (5)

2 screws (13)

- 17 Using your fingertips, carefully pry up the inside edge of the display assembly.
- 18 Lift the chassis away from the display assembly.
- 19 Release the camera cables, touch-screen control board cables, backlight cable, and LVDS cable through the slots on the chassis.

## Replacing the Display Assembly

- 1 Follow the instructions in "Before You Begin" on page 11.
- 2 Place the display assembly on the chassis.
- 3 Slide the camera cables, touch-screen control board cables, backlight cable and LVDS cable through the slots on the chassis.

- 4 Align the display assembly over the chassis and gently snap the chassis into place.
  - 5 Replace the five screws that secure the chassis to the display assembly.
  - 6 Replace the 13 screws that secure the chassis to the display bezel.
  - 7 Route the camera cables, touch-screen control board cables, backlight cable and LVDS cable through the routing guides.
  - 8 Connect the cables to the connectors on the system board, touch-screen control board, AV board, and the converter board.
  - 9 Replace the middle frame. See "Replacing the Middle Frame" on page 72.
  - 10 Replace the processor heat-sink fan. See "Replacing the Processor Heat-Sink Fan" on page 76.
  - 11 Replace the AV board. See "Replacing the Audio Video (AV) Board" on page 45.
  - 12 Replace the system-board shield. See "Replacing the System-Board Shield" on page 54.
  - 13 Replace the rear I/O cover. See "Replacing the Rear I/O Cover" on page 40.
  - 14 Replace the side I/O cover. See "Replacing the Side I/O Cover" on page 41.
  - 15 Follow the instructions from step 4 to step 6 in "Replacing the Optical Drive" on page 29.
  - 16 Replace the VESA mount. See "Replacing the VESA Mount" on page 38.
  - 17 Replace the rear-stand assembly. See "Replacing the Rear-Stand Assembly" on page 36.
  - 18 Replace the back cover. See "Replacing the Back Cover" on page 21.
-  **CAUTION: Before turning on the computer, replace all screws and ensure that no stray screws remain inside the computer. Failure to do so may result in damage to the computer.**
- 19 Connect your computer and all attached devices to electrical outlets, and turn them on.



# Display Panel

## Removing the Display Panel

- 1 Follow the instructions in "Before You Begin" on page 11.
- 2 Remove the display assembly. See "Removing the Display Assembly" on page 109.
- 3 Remove the four screws that secure the display panel to the display-panel chassis.

 **NOTE:** The number of screws that secure the display panel to the display-panel chassis may vary.

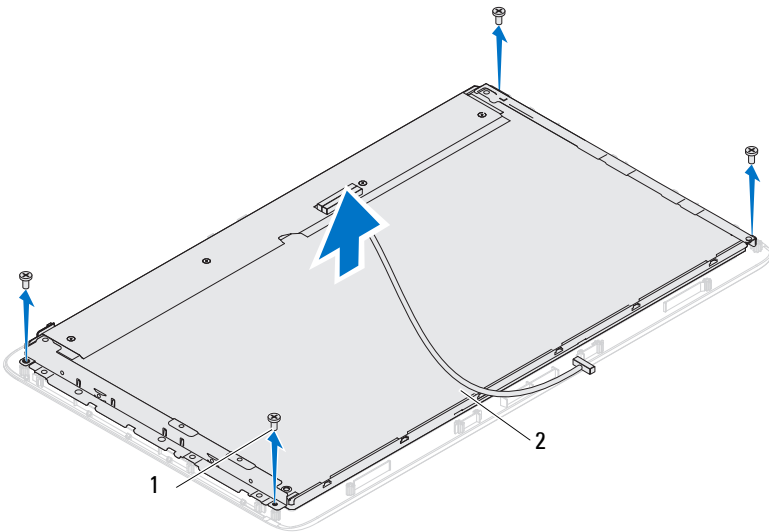

1 screws (4)

2 display panel

- 4 Lift the display panel off the display-panel chassis.

## Replacing the Display Panel

- 1 Follow the instructions in "Before You Begin" on page 11.

- 2 Align the screw holes on the display panel with the screw holes on the display-panel chassis and replace the four screws.
- 3 Replace the display assembly. "Replacing the Display Assembly" on page 111.

 **CAUTION: Before turning on the computer, replace all screws and ensure that no stray screws remain inside the computer. Failure to do so may result in damage to the computer.**

- 4 Connect your computer and all attached devices to electrical outlets, and turn them on.

## Display-Panel Brackets

### Removing the Display-Panel Brackets

- 1 Follow the instructions in "Before You Begin" on page 11.
- 2 Remove the display assembly. See "Removing the Display Assembly" on page 109.
- 3 Remove the display panel. See "Removing the Display Panel" on page 113.
- 4 Turn the display panel over.
- 5 Press the locking tabs on the LVDS cable to release the LVDS cable from the connector on the display panel.
- 6 Remove the four screws (two on each side) that secure the display-panel brackets to the display panel.

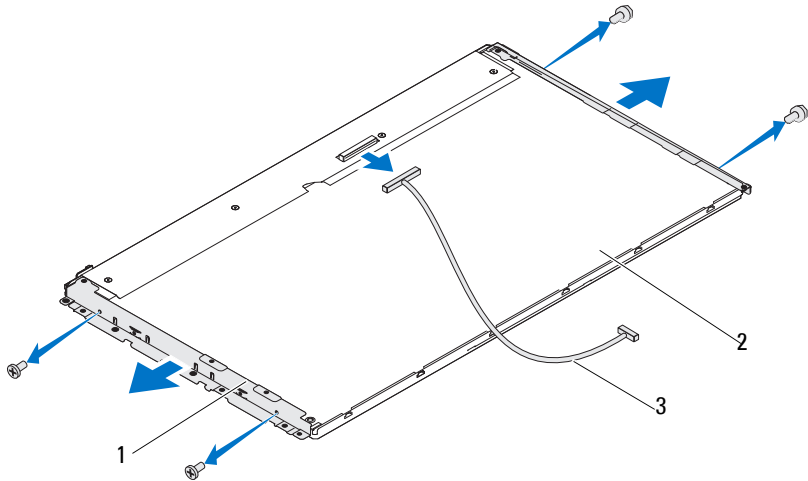

- 1 display-panel brackets (2)
- 2 display panel
- 3 LVDS cable

### Replacing the Display-Panel Brackets

- 1 Follow the instructions in "Before You Begin" on page 11.
- 2 Replace the four screws (two on each side) that secure the display-panel brackets to the display panel.
- 3 Connect the LVDS cable to the connector on the display panel.
- 4 Replace the display panel. See "Replacing the Display Panel" on page 113.
- 5 Replace the display assembly. "Replacing the Display Assembly" on page 111.





**CAUTION:** Before turning on the computer, replace all screws and ensure that no stray screws remain inside the computer. Failure to do so may result in damage to the computer.

- 6 Connect your computer and all attached devices to electrical outlets, and turn them on.



## Camera Module

-  **WARNING:** Before working inside your computer, read the safety information that shipped with your computer. For additional safety best practices information, see the Regulatory Compliance Homepage at [dell.com/regulatory\\_compliance](http://dell.com/regulatory_compliance).
-  **CAUTION:** Only a certified service technician should perform repairs on your computer. Damage due to servicing that is not authorized by Dell is not covered by your warranty.
-  **CAUTION:** To avoid electrostatic discharge, ground yourself by using a wrist grounding strap or by periodically touching an unpainted metal surface (such as a connector on your computer).

### Removing the Camera Module

- 1 Follow the instructions in "Before You Begin" on page 11.
- 2 Remove the back cover. See "Removing the Back Cover" on page 19.
- 3 Follow the instructions from step 3 to step 18 in "Removing the Display Assembly" on page 109.
- 4 Disconnect the camera cable from the connector on the camera module and lift the camera module off the display bezel.
- 5 Remove the two screws that secure the camera module to the camera-module assembly.
- 6 Lift the camera-module away from the camera-module assembly.

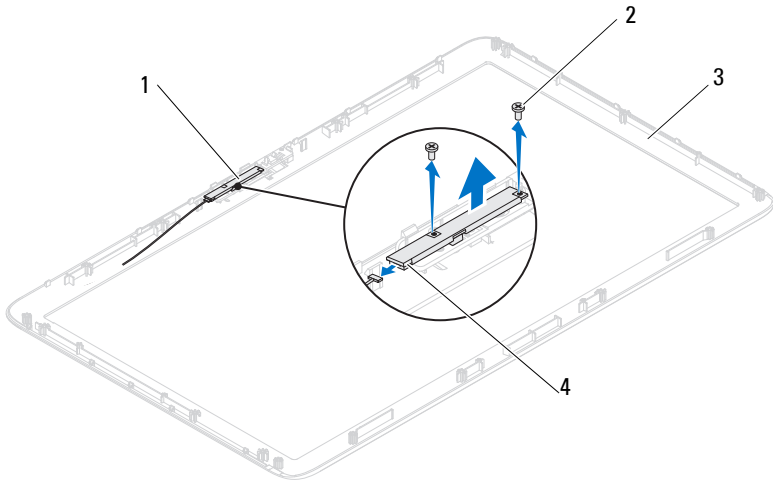

- |   |                        |   |                        |
|---|------------------------|---|------------------------|
| 1 | camera-module assembly | 2 | screws (2)             |
| 3 | display bezel          | 4 | camera-cable connector |

## Replacing the Camera Module

- 1 Follow the instructions in "Before You Begin" on page 11.
- 2 Align the screw holes on the camera module with the screw holes on the camera-module assembly.
- 3 Replace the two screws that secure the camera module to the camera-module assembly.
- 4 Place the camera-module assembly on the display bezel and connect the camera cable to the camera-cable connector on the camera-module assembly.
- 5 Follow the instructions from step 2 to step 17 in "Replacing the Display Assembly" on page 111.
- 6 Replace the back cover. See "Replacing the Back Cover" on page 21.





**CAUTION:** Before turning on the computer, replace all screws and ensure that no stray screws remain inside the computer. Failure to do so may result in damage to the computer.

- 7 Connect your computer and all attached devices to electrical outlets, and turn them on.





# Speaker Cover

-  **WARNING:** Before working inside your computer, read the safety information that shipped with your computer. For additional safety best practices information, see the Regulatory Compliance Homepage at [dell.com/regulatory\\_compliance](http://dell.com/regulatory_compliance).
-  **CAUTION:** Only a certified service technician should perform repairs on your computer. Damage due to servicing that is not authorized by Dell is not covered by your warranty.
-  **CAUTION:** To avoid electrostatic discharge, ground yourself by using a wrist grounding strap or by periodically touching an unpainted metal surface (such as a connector on your computer).

## Removing the Speaker Cover

- 1 Follow the instructions in "Before You Begin" on page 11.
- 2 Remove the back cover. See "Removing the Back Cover" on page 19.
- 3 Remove the rear-stand assembly. See "Removing the Rear-Stand Assembly" on page 35.
- 4 Remove the feet. See "Removing the Feet" on page 69.
- 5 Follow the instructions from step 3 to step 5 in "Removing the Optical Drive" on page 27.
- 6 Remove the VESA mount. See "Removing the VESA Mount" on page 37.
- 7 Remove the rear I/O cover. See "Removing the Rear I/O Cover" on page 39.
- 8 Remove the side I/O cover. See "Removing the Side I/O Cover" on page 41.
- 9 Remove the system-board shield. See "Removing the System-Board Shield" on page 53.
- 10 Remove the AV board. See "Removing the Audio Video (AV) Board" on page 43.
- 11 Remove the middle frame. See "Removing the Middle Frame" on page 71.
- 12 Remove the six screws that secure the speaker cover to the chassis.
- 13 Release the four tabs that secure the speaker cover to the chassis.

- 14 Pry and remove the speaker cover away from the computer.

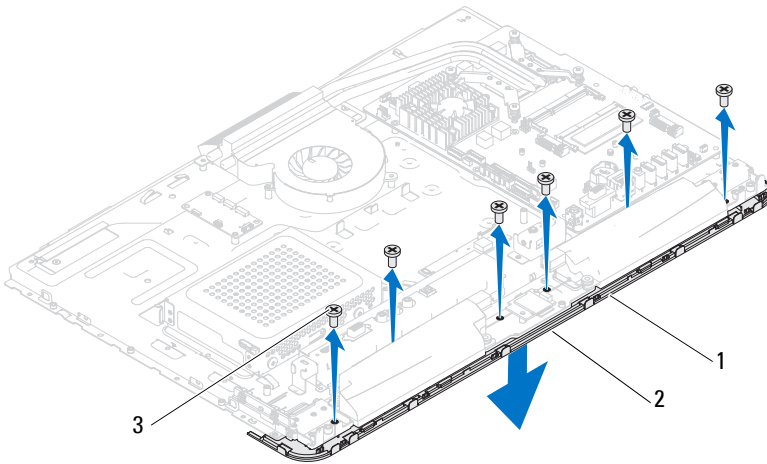

- 1 speaker cover
- 2 tabs (4)
- 3 screws (6)

## Replacing the Speaker Cover

- 1 Follow the instructions in "Before You Begin" on page 11.
- 2 Secure the four tabs on the speaker cover to the slots on the chassis.
- 3 Align the screw holes on the speaker cover with the screw holes on the chassis.
- 4 Replace the six screws that secure the speaker cover to the chassis.
- 5 Replace the middle frame. See "Replacing the Middle Frame" on page 72.
- 6 Replace the AV board. See "Replacing the Audio Video (AV) Board" on page 45.
- 7 Replace the system-board shield. See "Replacing the System-Board Shield" on page 54.
- 8 Replace the rear I/O cover. See "Replacing the Rear I/O Cover" on page 40.

- 9 Replace the side I/O cover. See "Replacing the Side I/O Cover" on page 41.
  - 10 Follow the instructions from step 4 to step 6 in "Replacing the Optical Drive" on page 29.
  - 11 Replace the VESA mount. See "Replacing the VESA Mount" on page 38.
  - 12 Replace the rear-stand assembly. See "Replacing the Rear-Stand Assembly" on page 36.
  - 13 Replace the back cover. See "Replacing the Back Cover" on page 21.
-  **CAUTION: Before turning on the computer, replace all screws and ensure that no stray screws remain inside the computer. Failure to do so may result in damage to the computer.**
- 14 Connect your computer and all attached devices to electrical outlets, and turn them on.



# System Setup

## Overview

Use the system setup to:

- Change the system configuration information after you add, change, or remove any hardware in your computer
- Set or change a user-selectable option such as the user password
- Read the current amount of memory or set the type of hard drive installed



**NOTE:** Before you change system setup, it is recommended that you write down the system setup screen information for future reference.

## Entering System Setup

- 1 Turn on (or restart) your computer.
- 2 When the DELL logo is displayed, watch for the F2 prompt to appear and then press <F2> immediately.



**NOTE:** The F2 prompt indicates that the keyboard has initialized. This prompt can appear very quickly, so you must watch for it, and then press <F2>. If you press <F2> before the F2 prompt, this keystroke is lost. If you wait too long and the operating system logo appears, continue to wait until you see the Microsoft Windows desktop. Then, turn off your computer and try again. See "Turning Off Your Computer" on page 11.

## System Setup Screens

The system setup screen displays current or changeable configuration information for your computer. Information on the screen is divided into three areas: the **setup item**, active **help** screen, and **key functions**.

<p><b>Setup Item</b> — This field appears on the left side of the system setup window. The field is a scrollable list containing features that define the configuration of your computer, including installed hardware, power conservation, and security features.</p> <p>Scroll up and down the list with the up- and down-arrow keys. As an option is highlighted, the <b>Help Screen</b> displays more information about that option and available settings.</p>	<p><b>Help Screen</b> — This field appears on the right side of the system setup window and contains information about each option listed in the <b>Setup Item</b>. In this field you can view information about your computer and make changes to your current settings.</p> <p>Press the up-arrow and down-arrow keys to highlight an option. Press &lt;Enter&gt; to make that selection active and return to the <b>Setup Item</b>.</p> <p><b>NOTE:</b> Not all settings listed in the <b>Setup Item</b> are changeable.</p>
<p><b>Key Functions</b> — This field appears below the <b>Help Screen</b> and lists keys and their functions within the active system setup field.</p>	

### System Setup Options

 **NOTE:** Depending on your computer and installed devices, the items listed in this section may appear, or may not appear exactly as listed.

---

<b>Main</b>	
System Information	Displays the system name
BIOS Version	Displays the BIOS version number
System Date	Displays the current date in mm/dd/yyyy format
System Time	Displays the current time in hh:mm:ss format
Service Tag	Displays the service tag of the computer
Asset Tag	Displays the asset tag of the computer when the asset tag is present
Processor Information	Displays the processor information

Processor Type	Displays the processor type
L1 Cache size	Displays the L1 cache size
L2 Cache size	Displays the L2 cache size
L3 Cache size	Displays the L3 cache size
Memory Information	
Memory Installed	Indicates the amount of memory installed in MB
Memory Available	Indicates the amount of memory available in MB
Memory Speed	Indicates the memory speed in MHz
Memory Technology	Indicates the type of installed memory
Device Information	
SATA 0	Displays the SATA drive connected to the SATA 0 connector
SATA 1	Displays the SATA drive connected to the SATA 1 connector

---

## Advanced

---

System Configuration	<ul style="list-style-type: none"> <li>• Onboard Audio Controller — Enabled or Disabled (Enabled by default)</li> <li>• SATA Mode — ATA Mode or AHCI Mode (AHCI Mode by default)</li> <li>• Onboard LAN Controller — Enabled or Disabled (Enabled by default)</li> <li>• Onboard LAN Boot ROM — Enabled or Disabled (Disabled by default)</li> <li>• DVMT/FIXED Memory — Select DVMT/FIXED mode memory size used by Internal Graphics Device</li> <li>• USB Controller — Enabled or Disabled (Enabled by default)</li> </ul>
----------------------	--

## Power Management

- AC Recovery — Power On; Power Off; Last State (Power Off by default)
- Remote Wake up — Enabled or Disabled (Enabled by default)
- Auto Power On — Enabled or Disabled (Disabled by default)
- Auto Power On Date — 0 to 31 (15 by default)
- Auto Power On hour — 0 to 23 (12 by default)
- Auto Power On minute — 0 to 59 (30 by default)
- Auto Power On second — 0 to 59 (30 by default)

## Post Behavior

- NumLock key — On or Off (On by default)
- Keyboard Errors — Report or Do Not Report (Report by default)



CPU Feature

- Hyper-Threading — Enabled or Disabled (Enabled by default)
- Multi Core Support — All; 1; 2; 3; (All by default) Number of cores to enable in each processor package
- Limit CPUID Value — Enabled or Disabled (Disabled by default). This field limits the maximum value the processor Standard CPUID Function will support.
- CPU XD Support — Enabled or Disabled (Enabled by default). XD can prevent certain classes of malicious buffer overflow attacks when combined with supporting operating systems.
- Intel Virtualization Technology — Enabled or Disabled (Enabled by default). When enabled, VMM utilizes the additional hardware capabilities provided by Vanderpool Technology.
- Intel(R) SpeedStep — Enabled or Disabled (Enabled by default).

---

**Security**

---

Admin Password Status	Displays administrator password
System Password Status	Displays system password
Admin Password	Allows to set, change, or delete the administrator password <b>NOTE:</b> Deleting administrator password deletes the system password. Hence, set the administrator password before setting the system password.
System Password	Allows to set, change, or delete the system password
Boot Menu Security	Enabled or Disabled (Disabled by default)

HDD protection	Enabled or Disabled (Disabled by default)
----------------	---

---

**Boot**

---

1st Boot Priority	Specifies the boot sequence from the available devices Diskette Drive; Hard Drive; USB Storage Device; CD/DVD/CD-RW Drive; Network; Disabled (Hard Drive by default)
-------------------	---

2nd Boot Priority	Specifies the boot sequence from the available devices Diskette Drive; Hard Drive; USB Storage Device; CD/DVD/CD-RW Drive; Network; Disabled (CD/DVD/CD-RW Drive by default)
-------------------	---

3rd Boot Priority	Specifies the boot sequence from the available devices Diskette Drive; Hard Drive; USB Storage Device; CD/DVD/CD-RW Drive; Network; Disabled (Diskette Drive by default)
-------------------	---

4th Boot Priority	Specifies the boot sequence from the available devices Diskette Drive; Hard Drive; USB Storage Device; CD/DVD/CD-RW Drive; Network; Disabled (Network by default)
-------------------	--

5th Boot Priority	Specifies the boot sequence from the available devices Diskette Drive; Hard Drive; USB Storage Device; CD/DVD/CD-RW Drive; Network; Disabled (USB Storage Device by default)
-------------------	---

---

**Exit**

---

Exit Options	Provides options to <b>Save Changes and Reset, Discard Changes and Reset, and Load Defaults</b>
--------------	---

---

## Boot Sequence

This feature allows you to change the boot sequence for devices.

### Boot Options

- **Diskette Drive** — The computer attempts to boot from the floppy disk drive. If no operating system is on the drive, the computer generates an error message.
- **Hard Drive** — The computer attempts to boot from the primary hard drive. If no operating system is on the drive, the computer generates an error message.
- **CD/DVD/CD-RW Drive** — The computer attempts to boot from the CD/DVD/CD-RW drive. If no CD/DVD/CD-RW is in the drive, or if the CD/DVD/CD-RW has no operating system, the computer generates an error message.
- **USB Storage Device** — Insert the memory device into a USB connector and restart the computer. When **F12 Boot Options** appears in the lower-right corner of the screen, press <F12>. The BIOS detects the device and adds the USB flash option to the boot menu.



**NOTE:** To boot to a USB device, the device must be bootable. To ensure that your device is bootable, check the device documentation.

- **Network** — The computer attempts to boot from the network. If no operating system is found on the network, the computer generates an error message.

### Changing Boot Sequence for the Current Boot

You can use this feature to change the current boot sequence, for example, to boot from the CD/DVD/CD-RW drive to run Dell Diagnostics from the *Drivers and Utilities* disc. On completion of diagnostic tests, the previous boot sequence is restored.

- 1 If you are booting from a USB device, connect the USB device to a USB connector.
- 2 Turn on (or restart) your computer.
- 3 When **F2 Setup**, **F12 Boot Options** appears in the lower-right corner of the screen, press <F12>.

 **NOTE:** If you wait too long and the operating system logo appears, continue to wait until you see the Microsoft Windows desktop. Then shut down your computer and try again.

The **Boot Device Menu** appears, listing all available boot devices.

- 4 On the **Boot Device Menu** choose the device you want to boot from.  
For example, if you are booting to a USB memory key, highlight **USB Storage Device** and press <Enter>.

 **NOTE:** To boot to a USB device, the device must be bootable. To ensure your device is bootable, check the device documentation.

### Changing Boot Sequence for Future Boots

- 1 Enter system setup. See "Entering System Setup" on page 125.
- 2 Use the arrow keys to highlight the **Boot** menu option and press <Enter> to access the menu.

 **NOTE:** Write down your current boot sequence in case you want to restore it.

- 3 Press the up- and down-arrow keys to move through the list of devices.
- 4 Press plus (+) or minus (-) to change the boot priority of the device.

## Clearing Forgotten Passwords

 **WARNING:** Before you begin any of the procedures in this section, follow the safety instructions that shipped with your computer.

 **WARNING:** The computer must be disconnected from the electrical outlet to clear the CMOS setting.

 **CAUTION:** Only a certified service technician should perform repairs on your computer. Damage due to servicing that is not authorized by Dell is not covered by your warranty.

 **CAUTION:** To avoid electrostatic discharge, ground yourself by using a wrist grounding strap or by periodically touching an unpainted metal surface (such as a connector on your computer).

- 1 Follow the instructions in "Before You Begin" on page 11.
- 2 Remove the back cover. See "Removing the Back Cover" on page 19.
- 3 Remove the rear-stand assembly. See "Removing the Rear-Stand Assembly" on page 35.



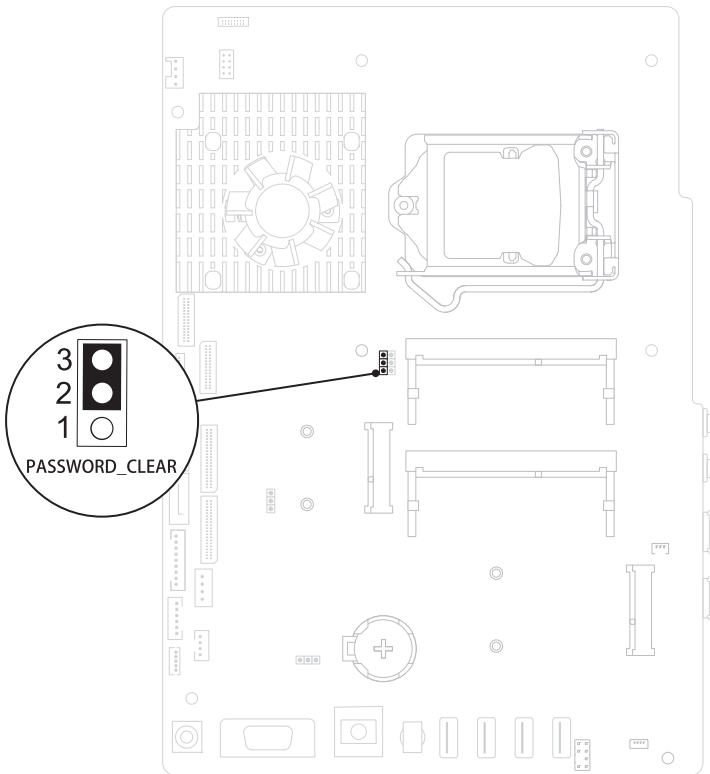

- 4 Remove the rear I/O cover. See "Removing the Rear I/O Cover" on page 39.
- 5 Remove the side I/O cover. See "Removing the Side I/O Cover" on page 41.
- 6 Remove the system-board shield. See "Removing the System-Board Shield" on page 53.
- 7 Locate the 3-pin password reset jumper (PASSWORD\_CLEAR) on the system board. See "System Board Components" on page 17.
- 8 Remove the 2-pin jumper plug from pins 2 and 3 and fix it on pins 1 and 2.



- 9 Wait for approximately five seconds to clear the password setting.
- 10 Remove the 2-pin jumper plug from pins 1 and 2 and replace it on pins 2 and 3.

- 11 Replace the system-board shield. "Replacing the System-Board Shield" on page 54.
  - 12 Replace the rear I/O cover. See "Replacing the Rear I/O Cover" on page 40.
  - 13 Replace the side I/O cover. See "Replacing the Side I/O Cover" on page 41.
  - 14 Replace the rear-stand assembly. See "Replacing the Rear-Stand Assembly" on page 36.
  - 15 Replace the back cover. See "Replacing the Back Cover" on page 21.
-  **CAUTION: Before turning on the computer, replace all screws and ensure that no stray screws remain inside the computer. Failure to do so may result in damage to the computer.**
- 16 Connect your computer and devices to electrical outlets, and turn them on.

## Clearing CMOS Passwords

-  **WARNING: Before you begin any of the procedures in this section, follow the safety instructions that shipped with your computer.**
-  **WARNING: The computer must be disconnected from the electrical outlet to clear the CMOS setting.**
-  **CAUTION: Only a certified service technician should perform repairs on your computer. Damage due to servicing that is not authorized by Dell is not covered by your warranty.**
-  **CAUTION: To avoid electrostatic discharge, ground yourself by using a wrist grounding strap or by periodically touching an unpainted metal surface (such as a connector on your computer).**
- 1 Follow the instructions in "Before You Begin" on page 11.
  - 2 Remove the back cover. See "Removing the Back Cover" on page 19.
  - 3 Remove the rear-stand assembly. See "Removing the Rear-Stand Assembly" on page 35.
  - 4 Remove the rear I/O cover. See "Removing the Rear I/O Cover" on page 39.
  - 5 Remove the side I/O cover. See "Removing the Side I/O Cover" on page 41.
  - 6 Remove the system-board shield. See "Removing the System-Board Shield" on page 53.

- 7** Locate the 3-pin password reset jumper (CMOS\_CLEAR) on the system board. See "System Board Components" on page 17.
- 8** Remove the 2-pin jumper plug from pins 2 and 3 and fix it on pins 1 and 2.

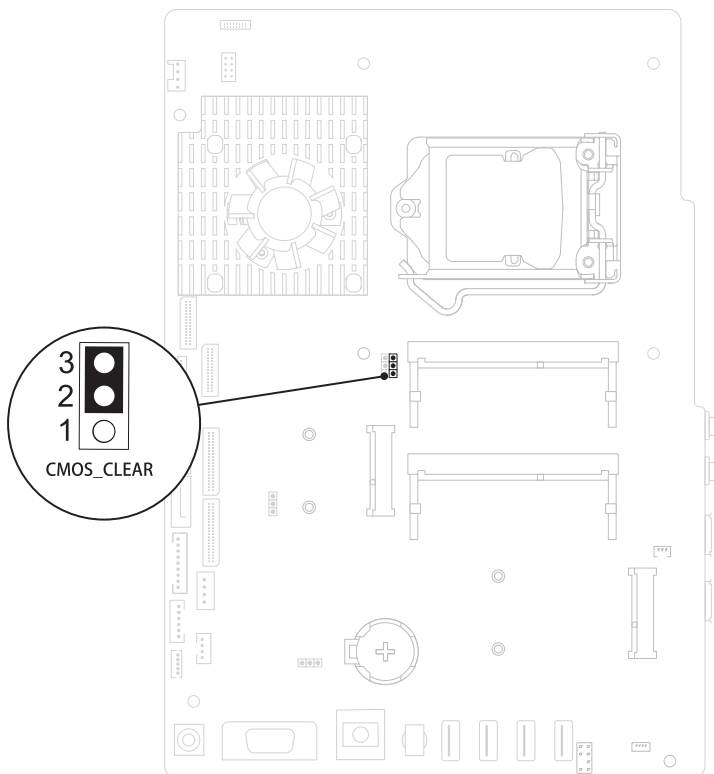

- 9** Wait for approximately five seconds to clear the CMOS setting.
- 10** Remove the 2-pin jumper plug from pins 1 and 2 and replace it on pins 2 and 3.
- 11** Replace the system-board shield. "Replacing the System-Board Shield" on page 54.
- 12** Replace the rear I/O cover. See "Replacing the Rear I/O Cover" on page 40.
- 13** Replace the side I/O cover. See "Replacing the Side I/O Cover" on page 41.

**14** Replace the rear-stand assembly. See "Replacing the Rear-Stand Assembly" on page 36.

**15** Replace the back cover. See "Replacing the Back Cover" on page 21.



**CAUTION: Before turning on the computer, replace all screws and ensure that no stray screws remain inside the computer. Failure to do so may result in damage to the computer.**

**16** Connect your computer and devices to electrical outlets, and turn them on.



## Flashing the BIOS

The BIOS may require flashing when an update is available or when replacing the system board. To flash the BIOS:

- 1 Turn on the computer.
- 2 Go to [support.dell.com/support/downloads](http://support.dell.com/support/downloads).
- 3 Locate the BIOS update file for your computer:



**NOTE:** The Service Tag for your computer is located on a label at the back of your computer.

If you have your computer's Service Tag:

- a Click **Enter a Tag**.
- b Enter your computer's Service Tag in the **Enter a service tag:** field, click **Go**, and proceed to step 4.

If you do not have your computer's Service Tag:

- a Click **Select Model**.
- b Select the type of product in the **Select Your Product Family** list.
- c Select the product brand in the **Select Your Product Line** list.
- d Select the product model number in the **Select Your Product Model** list.



**NOTE:** If you have selected a different model and want to start over again, click **Start Over** on the top right of the menu.

- e Click **Confirm**.
- 4 A list of results appears on the screen. Click **BIOS**.
- 5 Click **Download Now** to download the latest BIOS file. The **File Download** window appears.
- 6 Click **Save** to save the file on your desktop. The file downloads to your desktop.
- 7 Click **Close** if the **Download Complete** window appears. The file icon appears on your desktop and is titled the same as the downloaded BIOS update file.

- 8 Double-click the file icon on the desktop and follow the instructions on the screen.